



Room Temperature Controller

RCC20

for two-pipe fan coil units with electrical heater

Outputs for on / off valve actuator and electrical heater

Output for three-speed fan

Control depending on the room or return air temperature

Automatic heating / cooling changeover

Operating modes: normal, energy saving and frost protection mode or OFF

Operating mode changeover input for remote control

Selectable control parameters

Operating voltage AC 230 V

Use

Typical use:

- Control of the room temperature in individual rooms that are heated or cooled with two-pipe fan coil units equipped with an electrical heater.
- For opening or closing a valve
- for switching an electrical heater
- for switching a three-speed fan.

The controller acquires the room temperature with its integrated sensor or external room temperature sensor (QAA32) or external return air temperature sensor (QAH11.1) – if used – and maintains the setpoint by delivering control commands to the 2-point-valve. The switching differential can be 1 or 4 K in heating mode and 0.5 or 2 K in cooling mode.

Fan operation

The fan is switched to the selected speed via control output Q1, Q2 or Q3.

When the function “Temperature-dependent fan control” is activated (can be selected with DIP switch no.1), the fan is switched on / off depending on the temperature, that is, together with the valve.

It is switched off by

- leaving the heating or cooling sequence, provided the function “Temperature-dependent fan control” is activated, or
- manually changing to standby (⏸), provided plant conditions do not call for frost protection mode, or
- activating an external operating mode changeover switch, provided plant conditions do not call for energy saving or frost protection mode, or
- by turning the controller’s power supply off.

Note

To avoid overtemperatures of the electrical heater or to prevent the thermal cutout from responding, the fan will overrun for 30 seconds when the electrical heater is switched off. During that period of time, the fan LED flashes.



In the event of failure, the RCC20 cannot protect the electric heater against overtemperatures. For this reason, the electric heater must be equipped with a separate safety device (thermal cutout).

Heating and cooling mode

ON

The heating or cooling valve receives the **OPEN** command via control output Y11 when

1. the measured room temperature lies by half the switching differential below the setpoint (heating mode) or above the setpoint (cooling mode), and
2. the valve has been fully closed for more than one minute.

OFF

The heating or cooling valve receives the **CLOSE** command via control output Y11 when

1. the measured room temperature lies by half the switching differential above the setpoint (heating mode) or below the setpoint (cooling mode), and
2. the valve has been fully open for more than one minute.

Note: control output Y12 delivers a control command which is inverted to the control command at output Y11 and can be used for normally open valves

Return air temperature

The RCC20 provides control either depending on to the measured room temperature or depending on the fan coil unit’s return air temperature. Changeover is automatic if a QAH11.1 cable temperature sensor is used.

Automatic changeover

The water temperature acquired by the changeover sensor (QAH11.1 + ARG86.3) is used by the controller to switch from heating to cooling mode, or vice versa. When the water temperature lies above 28 °C, the controller switches to heating mode, below 16 °C it switches to cooling mode. If, immediately after switching on, the water temperature lies between the 2 changeover points, the controller will start in heating mode. The water temperature is measured at minute-intervals and the operational status updated.

Heating mode

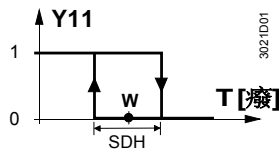

Cooling mode

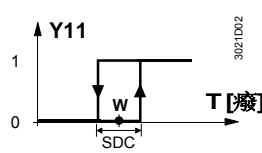

Automatic changeover

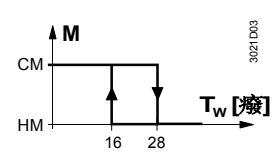

CM	Cooling mode	T _w	Water temperature
HM	Heating mode	w	Room temperature setpoint
M	Operating mode	Y11	Manipulated variable "Valve"
SDC	Switching differential "Cooling"	T	Room temperature
SDH	Switching differential "Heating"		

Purging function

The task of the changeover sensor is to initiate the change from heating to cooling mode even if the two-port valves are shut down for a longer period of time. To ensure this function, the valves are opened for one minute at 2-hour intervals during off hours. (Note: this function is not active when using thermal actuators).

Electric heating operation, active in the heating sequence

In addition to hot water heating operation, the electrical heater receives an **ON** command via Y21 when

1. the measured room temperature is $x \leq w - w_D - \frac{1}{2} SDH$, and
2. the electrical heater has been switched off for more than one minute.

The **OFF** command for the electrical heater is given when

1. the measured room temperature is $x \geq w - w_D + \frac{1}{2} SDH$, and
2. the electrical heater has been switched on for more than one minute.

When two heating sequences are selected, the two outputs cannot be switched ON the same time. Two outputs must be switched ON separately with at least 1 minute delay. In case of set-point change, the two heaters are allowed to switch OFF together.

Electric heating operation, active in the cooling sequence

For this operation, DIP switch no.8 must be set to **ON** (factory setting).

The electrical heater receives the ON command via control output Y21 when

1. the measured room temperature lies by half the switching differential below the adjusted setpoint, and
2. the electrical heater has been switched off for more than one minute.

The **OFF** command for the electrical heater is given when

1. the measured room temperature lies by half the switching differential above the adjusted setpoint, and
2. the electrical heater has been switched on for more than one minute.

Heating mode (hot water plus electric)

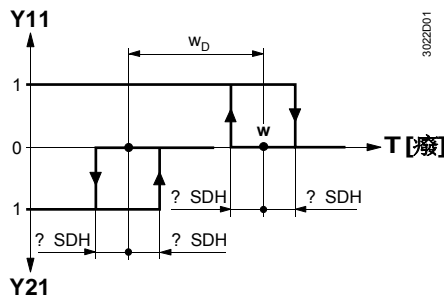

Cooling mode with optional electric heating sequence (DIP switch no.8 = ON)

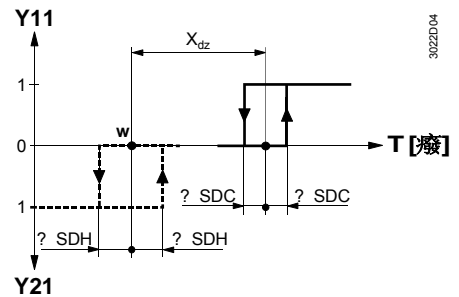

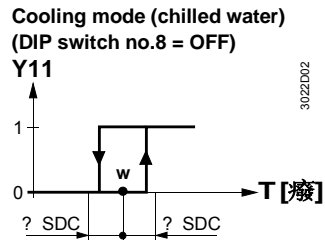

T[°C]	Room temperature	w	Room temperature setpoint
Y11	Manipulated variable «Valve»	Y21	Manipulated variable «Electric heating»
SDH	Switching differential "Heating"	w _D	Setpoint differential
Xdz	Dead zone	SDC	Switching differential "Cooling"

Energy saver

The room temperature setpoint can be limited in increments of 1 K by making use of the minimum and maximum limitation facility. Arbitrary setpoint readjustments can thus be presented.

Operating modes

The following operating modes are available:

Normal operation

Heating or cooling mode with automatic changeover and with manually selected fan speed III, II or I. In normal operation, the controller maintains the adjusted setpoint.

Frost protection mode

The frost protection function is activated only when DIP switch no.4 is set to OFF. Frost protection mode can be activated either

- by manually switching to standby (⏻).
- by activating the external operating mode changeover switch, provided DIP switch 2 is set to OFF

If the room temperature falls below 8 °C, the controller will automatically switch to frost protection mode. In that case, the heating valve opens and the fan operates at the selected speed. If the selector is in position standby (⏻), the fan will operate at speed I. The room temperature is maintained at a setpoint of 8 °C and the setpoint adjusted by the user will be ignored.

If frost protection operation is locked (DIP switch no. 4 in position ON), standby is locked also, which means that the controller will not switch to standby but to OFF.

Note

In frost protection mode, the electrical heater is always enabled, independent of the position of DIL switch no.8 (behaviour of electrical heater in cooling mode).

Energy saving mode

In energy saving mode, the setpoint of heating is 16°C and the setpoint of cooling 28 °C, independent of the position of the setpoint knob. This operating mode will be activated when input D1 for operating mode changeover is active and DIP switch no.2 is set to ON.

Operating mode changeover switch

A changeover switch can be connected to status input D1–GND. When the switch closes its contact (caused by an open window, for instance), the operating mode will change from normal operation to energy saving mode (provided DIP switch no.2 is set to ON), or from normal operation to standby (provided DIP switch no.2 is set to OFF). If the room temperature falls below 8 °C and if DIP switch no.4 is set to OFF, frost protection mode will become active.

The operating action of the switch (N.C. or N.O) can be selected.

Ordering

When ordering, please give name and type reference.

The QAH11.1 temperature sensor (can be used as a return air temperature or changeover sensor), the changeover mounting kit and the zone valve are to be ordered as separate items.

Equipment combinations

Type of unit	Type reference	Data sheet ^{*)}
Temperature sensor	QAH11.1	1840
Room sensor	QAA32	1747
Changeover mounting kit	ARG86.3	1840
Motoric on/off actuator	SFA21...	4863
Thermal actuator (for radiator valve)	STA21...	4893
Thermal actuator (for small valve 2,5 mm)	STP21...	4878

^{*)} The documents can be downloaded from <http://siemens.com/bt/download>.

Mechanical design

The unit consists of two parts:

- A plastic housing which accommodates the electronics, the operating elements and the built-in room temperature sensor
- A mounting base

The housing engages in the mounting base and snaps on.

The base carries the screw terminals; the DIP switches are located at the rear of the housing.

Setting and operating elements

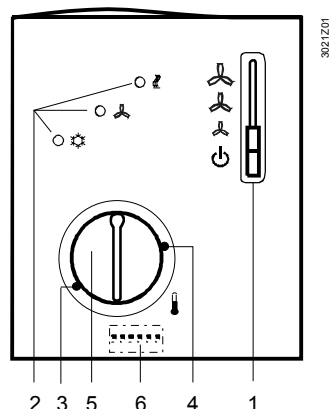

Legend

1. Operating mode selector (standby, heating or cooling mode with manual selection of fan speed)
- 2 LEDs for indicating heating mode, cooling mode and fan operation
- 3 Setting facility for minimum setpoint limitation (in increments of 1 K)
- 4 Setting facility for maximum setpoint limitation (in increments of 1 K)
- 5 Room temperature setpoint knob

6 Set of DIP switches

DIP switch no.	Meaning	Position ON	Position OFF
1	Fan control	Fan control is temperature-dependent in all operating modes	Fan control in normal operation is temperature-independent ¹⁾
2	Operating mode changeover via an external switch	Changeover between normal operation and energy saving mode	Changeover between normal operation and standby ¹⁾
3	Operating action of switch for external operating mode changeover	Changeover activated when contact of switch is closed (N.O.) ¹⁾	Changeover activated when contact of switch is open (N.C.)
4	Standby	Frost protection function not enabled	Frost protection function enabled ¹⁾
5	Switching differential	1 K in heating mode ¹⁾ 0.5 K in cooling mode ¹⁾	4 K in heating mode 2 K in cooling mode
6	Dead zone in normal operation	2 K ¹⁾	5 K
7	Setpoint differential	2 K ¹⁾	4 K
8	Electrical heater	Active in cooling mode ¹⁾	Inactive in cooling mode

1) Factory setting

Description	Type reference
Adapter plate 120 x 120 mm for 4" x 4" conduit boxes	ARG70
Adapter plate 96 x 120 mm for 2" x 4" conduit boxes	ARG70.1
Adapter plate for surface wiring 112x130 mm	ARG70.2

Engineering notes

In system without automatic changeover, the temperature sensor can be replaced by an external switch for manual changeover.

In system with continuous heating operation, no sensor will be connected to the controller's input.

With continuous cooling operation, the controller input (B2-M) must be bridged.

Mounting, installation and commissioning notes

Mounting location: on a wall or inside the fan coil unit. Not in niches or bookshelves, not behind curtains, above or near heat sources and not exposed to direct solar radiation.

Mounting height is about 1.5 m above the floor. The connecting wires can be run to the controller from a recessed conduit box.

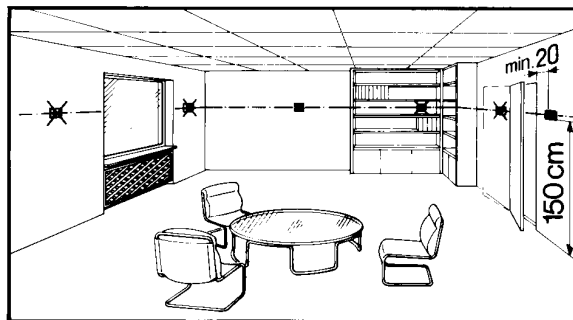

Check the settings of the DIL switches no.1 through no.8 and change them, if required. If setpoint limitation is required, use the minimum and maximum limitation facility (energy saver).

After applying power, the controller makes a reset during which the fan LED flashes indicating that the reset has been correctly made. This takes about 3 seconds. Then, the LED stops flashing and the controller will be ready to operate.

- Prior to fitting the changeover sensor, thermal conductive paste must be applied to the location on the pipe where the sensor placed
- The cables used must satisfy the insulation requirements with regard to mains potential
- Sensor inputs B1-M and B2-M carry mains potential. If the sensor's cables must be extended, the cables used must be suited for mains voltage



Warning!

No internal line protection for supply lines to external consumers (Q1, Q2, Q3, Y11, Y12, Y21)

Risk of fire and injury due to short-circuits!

- Adapt the line diameters as per local regulations to the rated value of the installed overcurrent protection device.

The controller is supplied with Mounting Instructions.

Disposal



The device is considered an electronic device for disposal in terms of the European Directive 2012/19/EU and may not be disposed of as domestic garbage.

- Dispose of the device through channels provided for this purpose.
- Comply with all local and currently applicable laws and regulations.

Technical data

Power supply

Operating voltage AC 230 V + 10/-15 %

Frequency 50/60 Hz

Power consumption max. 6 VA



No internal fuse

External preliminary protection with max. C 10 A circuit breaker in the supply line required under all circumstances

Control outputs Q1, Q2, Q3 AC 230 V

Rating max. 600 VA

Control output Y11 (N.O. contact) AC 230 V

Rating max. 300 VA

Control output Y12 (N.C. contact) AC 230 V

Rating max. 300 VA

Control output Y21 (N.O. contact) AC 230 V

Rating max. 1250 VA

Signal input B1 for return air sensor QAH11.1, Safety class II
NTC resistor 3kΩ at 25°C

Signal input B2 for changeover-sensor QAH11.1, Safety class II
NTC resistor 3kΩ at 25°C

Status input D1 and GND

Contact sensing SELV DC 6-15V / 3-6 mA

Insulation against mains 4 kV, extra insulation

Perm. cable length with copper cable 1.5 mm²
for connection to terminals B1, B2 and D1 80 m

Operational data

Setpoint setting range 8...30 °C

Max. control deviation at 25 °C max. ±0.7 K

Switching differential in heating mode SDH (selectable) 1 K or 4 K

Switching differential in cooling mode SDC (selectable) 0.5 K or 2 K

Dead zone Xdz in normal operation 2 K or 5 K

Setpoint «Energy saving mode (C)», heating 16 °C

Setpoint «Energy saving mode (C)», cooling 28 °C

Setpoint «Standby (L)» 8 °C

Environmental conditions

Operation to IEC 60721-3-3

Climatic conditions class 3K5

Temperature 0...+50 °C

Humidity <95 % r.h.

Transport to IEC 60721-3-2

Climatic conditions class 2K3

Temperature -25...+70 °C

Humidity <95 % r. h..

Mechanical conditions class 2M2

Norms and standards	Storage	to IEC 60721-3-1
	Climatic conditions	class 1K3
	Temperature	-25...+70 °C
	Humidity	<95 % r. h..
	EU Conformity (CE)	CE1T3020xx ^{*)}
	RCM Conformity	CE1T3020en_C1 ^{*)}
	Safety class	II to EN 60 730-1
Environmental compatibility	Pollution class	normal
	Degree of protection of housing	IP30 to EN 60 529
General	The product environmental declaration CE1E3020 ^{*)} contains data on environmentally compatible product design and assessments (RoHS compliance, materials composition, packaging, environmental benefit, disposal).	
General	Connection terminals	Use solid wires or prepared stranded wires. 2 x 0.4-1.5 mm ² or 1 x 2.5 mm ²
	Weight	0.23 kg
	Colour of housing front	white, NCS S 0502-G (RAL9003)
	*) The documents can be downloaded from http://siemens.com/bt/download .	

Connection terminals

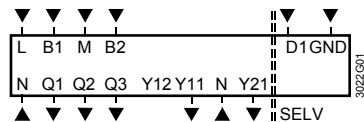

L, N Operating voltage AC 230 V

B1 Status input "Return air temperature sensor"

M Measuring neutral "Return air temperature sensor and changeover sensor"

B2 Status input "Changeover sensor"

D1, GND Status input for potential-free operating mode changeover switch (operating action can be selected)

Q1 Control output "Fan speed I" AC 230 V

Q2 Control output "Fan speed II" AC 230 V

Q3 Control output "Fan speed III" AC 230 V

Y11 Control output "Valve" AC 230 V (N.O. contact, for N.C. valves)

Y12 Control output "Valve" AC 230 V (N.C. contact, for N.O. valves)

Y21 Control output "Electric heating" AC 230 V

Connection diagram

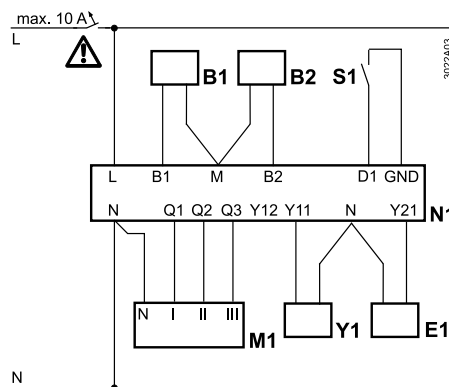

B1 Return air temperature sensor (QAH11.1)

B2 Changeover sensor (QAH11.1 temperature sensor + ARG863.3 changeover mounting kit)

E1 Electrical heater

M1 Three-speed fan

N1 RCC20 room temperature controller

S1 External operating mode changeover switch

Y1 MVE..., MXE... zone valve

Dimensions

Unit/baseplate

