



Room thermostats with KNX communications RDG400KN,RDG405KN Basic Documentation

Edition: 4.0

CE1P3192en
2019-04-12

Smart Infrastructure

1 / 86

Contents

1.	About this document	4
1.1	Revision history	4
1.2	Reference documents.....	4
1.3	How to find RDG400KN/RDG405KN applications in HIT	5
1.4	Before you start	5
1.4.1	Copyright.....	5
1.4.2	Quality assurance	5
1.4.3	Document use/request to the reader	5
1.5	Target audience, prerequisites	6
1.6	Glossary	6
2.	Summary	7
2.1	Types	7
2.2	Ordering	7
2.3	Functions.....	7
2.4	Integration via KNX bus	9
2.5	Equipment combinations.....	11
2.6	Accessories	12
3.	Functions	13
3.1	Temperature and IAQ control (RDG405KN only)	13
3.1.1	Temperature control	13
3.1.2	IAQ control (RDG405KN only)	14
3.2	Operating modes	16
3.2.1	Different ways to influence the operating mode	18
3.2.2	Communication examples.....	21
3.3	Room temperature setpoints.....	25
3.3.1	Description	25
3.3.2	Setting and readjusting setpoints	27
3.4	Applications overview	29
3.4.1	Applications with supply and extract air	30
3.5	Additional functions.....	31
3.6	Control sequences.....	33
3.6.1	Sequences overview (setting via P01).....	33
3.6.2	Hysteresis: Behavior of heating and cooling.....	34
3.6.3	Application mode	35
3.6.4	Minimum and maximum air volume.....	36
3.6.5	Single-duct applications	37
3.6.6	Single-duct applications with electric heater	38
3.6.7	Single-duct applications with radiator or floor heating	41
3.6.8	Single-duct applications with heating/cooling coil	43
3.6.9	Setpoints and sequences.....	45
3.6.10	Applications with external AQR sensor or QMX room operator unit (RDG405KN).....	46
3.7	Control outputs	47
3.7.1	Overview	47
3.7.2	Control output for air flow.....	47
3.7.3	Control output for electric heater, radiator and heating/ cooling coil	48

3.7.4	Control outputs configuration (setting via DIP switches 4 and 5 or tool, and P46...P47)	50
3.8	Multifunctional input, digital input.....	51
3.9	Handling faults.....	53
3.10	KNX communications.....	53
3.10.1	S-Mode.....	53
3.10.2	LTE-Mode.....	53
3.10.3	Zone addressing in LTE-Mode (in connection with Synco).....	55
3.10.4	Example of heating and cooling demand zone	56
3.10.5	Send heartbeat and receive timeout.....	57
3.10.6	Startup.....	57
3.10.7	Heating and cooling demand.....	58
3.10.8	Air demand	58
3.10.9	Electric heater interlock by supply air controller (LTE-Mode only).....	58
3.10.10	Primary fan overrun after switching off the electric heater	59
3.10.11	Fault function on KNX.....	59
3.10.12	Emergency control (LTE-Mode only)	60
3.10.13	Application with VAV compact controller (KNX LTE-Mode only)	60
3.11	Communication objects (S-Mode)	61
3.11.1	Overview	61
3.11.2	Description of communication objects	62
3.12	Communication objects (LTE-Mode)	64
3.13	Control parameters	65
3.13.1	Parameter setting via local HMI.....	65
3.13.2	Parameter setting/download via tool.....	66
3.13.3	Parameters of the Service level.....	67
3.13.4	Parameters of the Expert level with diagnostics and test	68
4.	Handling.....	70
4.1	Mounting and installation	70
4.2	Commissioning	71
4.3	Operation.....	73
4.4	Remote operation	75
4.5	Disposal	75
5.	Supported KNX tools.....	75
5.1	ETS.....	75
5.1.1	Parameter settings in ETS	75
5.2	ACS790.....	76
5.2.1	Parameter settings in ACS	76
5.2.2	Operation and monitoring with ACS.....	77
5.2.3	Operation and monitoring with OZW772.....	80
6.	Connection.....	80
6.1	Connection terminals	80
6.2	Connection diagrams.....	81
7.	Mechanical design.....	81
7.1	General	81
7.2	Dimensions.....	82
8.	Technical data.....	83

1. About this document

1.1 Revision history

Edition	Date	Changes	Section	Pages
4.0	Apr. 2019	<ul style="list-style-type: none">• Update connection terminals• Various corrections	Various	
3.1	Feb. 2017	<ul style="list-style-type: none">• Update “Heartbeat”	3.10.5	57
3.0	Dec. 2015	<ul style="list-style-type: none">• New features for new product RDG405KN: IAQ function	Various	
2.0	Dec. 2011	<ul style="list-style-type: none">• Amendments for new software V1.24• Various corrections	Various	
1.0	July 16, 2010	First edition	All	

1.2 Reference documents

Subject	Ref	Doc No.	Description
Room thermostats with KNX communications, RDG405KN	[18]	N3192	Data Sheet
	[19]	A6V10733816	Operating Instructions
	[20]	A6V10733804	Mounting Instructions
Room thermostats with KNX communications, RDG400KN	[1]	CE1N3192	Data Sheet
	[2]	CE1B3192	Operating Instructions
	[3]	CE1M3192	Mounting Instructions
KNX Manual	[4]		Handbook for Home and Building Control – Basic Principles (www.knx.org/uk/news-press/publications/publications/)
Synco and KNX (see www.siemens.com/synco)	[5]	CE1N3127	KNX bus, Data Sheet
	[6]	CE1P3127	Communication via the KNX bus for Synco 700, 900 and RXB/RXL, Basic Documentation
	[7]	XLS template in HIT	Planning and commissioning protocol, communication Synco 700
	[8]	CE1N3121	RMB795 central control unit, Data Sheet
	[9]	CE1Y3110	KNX S-Mode data points
	[10]	--	Product data for ETS
	[11]	CE1J3110	ETS product data compatibility list
[12]	0-92168en	Synco Application Manual	
Desigo engineering documents	[13]	CM1Y9775	Desigo RXB integration – S-Mode
	[14]	CM1Y9776	Desigo RXB/RXL integration – Individual Addressing
	[15]	CM1Y9777	Third-party integration
	[16]	CM1Y9778	Synco integration
	[17]	CM1Y9779	Working with ETS

1.3 How to find RDG400KN/RDG405KN applications in HIT

Select **Applications > Individual rooms** and set the search criteria as follows:

- Air Treatment: Type "Variable Air Volume"
- Preferred controller: Range "RDG / RDF"

Air Treatment		Preferred controller	
Type	Coil	Range	Operating voltage
Variable Air Volume ▼	- all - ▼	RDG / RDF ▼	- all - ▼
<input type="checkbox"/> Electric reheater		Mount	
		- all - ▼	

1.4 Before you start

1.4.1 Copyright

This document may be duplicated and distributed only with the express permission of Siemens, and may be passed only to authorized persons or companies with the required technical knowledge.

1.4.2 Quality assurance

This document was prepared with great care.

- The contents of this document is checked at regular intervals
- Any corrections necessary are included in subsequent versions
- Documents are automatically amended as a consequence of modifications and corrections to the products described

Please make sure that you are aware of the latest document revision date.

If you find lack of clarity while using this document, or if you have any criticisms or suggestions, please contact the Product Manager in your nearest branch office.

The addresses of the Siemens Regional Companies are available at www.buildingtechnologies.siemens.com.

1.4.3 Document use/request to the reader

Before using our products, it is important that you read the documents supplied with or ordered at the same time as the products (equipment, applications, tools, etc.) carefully and in full.

We assume that persons using our products and documents are authorized and trained appropriately and have the technical knowledge required to use our products as intended.

More information on the products and applications is available:

- On the intranet (Siemens employees only) at <https://workspace.sbt.siemens.com/content/00001123/default.aspx>
- From the Siemens branch office near you www.buildingtechnologies.siemens.com or from your system supplier
- From the support team at headquarters fieldsupport-zug.ch.sbt@siemens.com if there is no local point of contact

Siemens assumes no liability to the extent allowed under the law for any losses resulting from a failure to comply with the aforementioned points or for the improper compliance of the same.

1.5 Target audience, prerequisites

This document assumes that users of the RDG..KNX room thermostats are familiar with the ETS and/or Synco ACS tools and are able to use them.

It also presupposes that these users are aware of the specific conditions associated with KNX.

In most countries, specific KNX know-how is conveyed through training centers certified by the KNX Association (see www.konnex.org/).

For reference documentation, refer to section 1.2.

1.6 Glossary

The inputs, outputs and parameters of an application can be influenced in various ways. These are identified by the following symbols in this document:



Parameters identified by this symbol are set using the ETS tool.



Parameters identified by this symbol are set using the ACS tool.



Setting RDG..KNX parameters is only supported by the following tool versions:

- ETS4 or higher
- ACS790



Inputs and outputs identified by this symbol communicate with other KNX devices. They are called communication objects (CO).

The communication objects of the RDG..KNX room thermostats work partly in S-Mode, partly in LTE-Mode, and partly in both. These objects are described accordingly.

A list of the parameters is shown in section 3.12.

2. Summary

2.1 Types

Type	Features							
	Operating voltage	Number of control outputs				VAV control via KNX LTE-Mode	IAQ	Backlit LCD
On/Off		PWM	3-pos	DC 0...10 V				
RDG400KN	AC 24 V	1 ¹⁾	1 ¹⁾	1 ¹⁾	1	✓	---	✓
RDG405KN	AC 24 V	1 ¹⁾	1 ¹⁾	1 ¹⁾	1	✓	✓	✓

1) Selectable: On/Off, PWM or 3-position (triac outputs)

2.2 Ordering

Product No.	Stock No.	Description
RDG400KN	S55770-T165	Room thermostat
RDG405KN	S55770-T348	Room thermostat

Order valve actuators separately.

2.3 Functions

Use

VAV systems via On/Off or modulating control outputs or KNX LTE-Mode:

- Single-duct system
- Single-duct system with electric heater
- Single-duct system and radiator/floor heating
- Single-duct system with heating/cooling coil

The room thermostats are delivered with a fixed set of applications.

The required application is selected and activated during commissioning using one of the following tools:

- Synco ACS
- ETS
- Local DIP switch and HMI

Features

- Operating modes: Comfort, Economy (energy saving) and Protection
- Output for VAV box/air damper/VAV compact controller: DC 0...10 V/3-position (triac)/KNX LTE-Mode
- Output for heating/cooling coil: On/Off, PWM or 3-position (triac)/DC 0...10 V
- Output signal inversion as an option (DC 0...10 V → DC 10...0 V)
- Automatic or manual heating/cooling changeover
- Backlit LCD
- AC 24 V operating voltage
- Indoor air quality (IAQ) control loop with external CO₂/VOC sensor (DC 0...10 V or KNX LTE- and S-Mode)
- Window contact (RDG405KN)
- Presence detector (RDG405KN)
- Receive temperature via bus (RDG405KN)
- Selectable DC input (RDG405KN)

Functions

- Room temperature control via built-in sensor or external room temperature/return air temperature sensor or KNX room temperature sensor
- IAQ control via external CO₂/VOC sensor on the DC 0...10 V inputs KNX (LTE- or S-Mode)
- Changeover between heating and cooling mode (automatically via local sensor or bus, or manually)
- Selection of applications via DIP switches or commissioning tool (ACS790).
- Selection of operating mode via operating mode button on the thermostat
- Temporary Comfort mode extension
- Display of current room temperature or setpoint in °C and/or °F
- Display of CO₂ external sensor value in ppm or with symbols (+++; ++-; +--)
(RDG405KN)
- Display of outside temperature or time of day via KNX bus
- Minimum and maximum limitation of room temperature setpoint
- Minimum and maximum limitation of air flow signal DC 0...10 V/3-position
- External CO₂ sensor DC 0...10 V; 0...2000 ppm (RDG405KN)
- External CO₂ sensor, KNX; 0...5000 ppm (RDG405KN)
- Button lock (automatic or manual)
- 2 multifunctional inputs, freely selectable for:
 - Operating mode switchover contact (keycard, window contact, etc.)
(RDG400KN)
 - Window contact switching operating mode to Protection (RDG405KN)
 - Presence detector switching operating mode to Comfort (RDG405KN)
 - Sensor for automatic heating/cooling changeover
 - External room temperature or return air temperature sensor
 - Dewpoint sensor
 - Electric heater enable
 - Fault input
- Interworking with AQR and QMX sensor for IAQ and room temperature acquisition (RDG405KN)
- 1 multifunctional active DC input (RDG405KN), freely selectable for:
 - External IAQ sensor (CO₂, VOC)
 - Air damper position feedback (optimization of supply air fan's operation)
- Monitoring input for temperature sensor or switch state
- Feedback of air damper position via KNX bus or a DC 0...10V input for optimization of pressure control
- Floor heating temperature limitation
- Reloading factory settings for commissioning and control parameters

2.4 Integration via KNX bus

The RDG.. room thermostats can be integrated as follows:

- Integration into Synco 700 system via LTE-Mode (easy engineering)
- Integration into Synco living via group addressing (ETS)
- Integration into Desigo via group addressing (ETS) or individual addressing
- Integration into third-party systems via group addressing (ETS)

The following KNX functions are available:

- Central time program and setpoints, e.g. when using the RMB795 central control unit
- Outside temperature or time of day via bus displayed on the thermostat
- Remote operation and monitoring
- Remote operation and monitoring with web browser using the OZW772 or OZW775 web server
- Maximum energy efficiency due to exchange of relevant energy information, e.g. with Synco 700 controllers (e.g. heating/cooling demand, air damper position)
- Alarming, e.g. external fault contact, condensation, etc.
- Monitoring input for temperature sensor or switch

Engineering and commissioning can be performed using ...

- the local DIP switches/HMI
- the Synco ACS tool
- the ETS

Synco 700

The RDG.. room thermostats are especially tailored for integration into the Synco 700 system and operate together in KNX LTE-Mode. This extends the field of use of Synco for individual room control in connection with fan coil units, VAV, chilled ceilings and radiators.

Synco living

Thanks to S-Mode extension to the QAX910 central apartment unit, communicating room thermostats can be easily integrated into Synco living systems. Using the S-Mode data points of the central apartment unit, additional room information can be exchanged with the room thermostat via KNX TP1 (RF function is not available on the room thermostats). To make the integration, the ETS engineering tool is required.

Synco topology

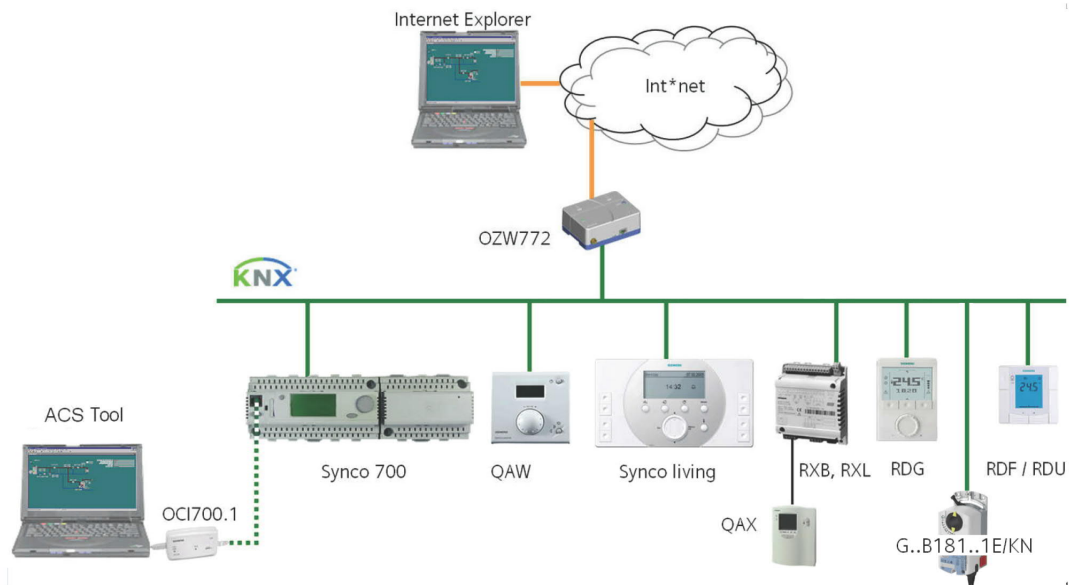







Legend:	Synco 700	Building automation and control system (BACS)
	Synco living	Room automation and control system
	RDG.., RDF.., RDU..	Room thermostats
	OZW772 (or OZW775)	Web server
	QAW..	Room unit
	ACS tool	Service tool using OCI702 (OCI702) is delivered with a service cable which can be plugged into the service connector on a Synco controller)
	RXB, RXL	Room controllers
QAX	Room unit for RXB/RXL room controllers	
G..B181..1E/KN	VAV compact controller for KNX LTE-Mode	

Designo and third-party systems







The RDG..KNX devices can be integrated into the Siemens building automation and control systems (BACS) Designo or 3rd-party systems. For integration, either S-Mode (group addressing) or individual addressing can be used. The workflow for integration into Designo is the same as with standard KNX devices.

2.5 Equipment combinations



Sensors











Type of unit		Product No.	Data Sheet
Cable temperature sensor		QAH11.1	1840
Room temperature sensor		QAA32	1747
Condensation monitor		QXA21..	A6V10741072
Flush-mount KNX room sensor (base and front module)		AQR2576N... AQR2530NNW AQR2532NNW AQR2535NNW AQR2535NNWQ	1411
Flush-mounted room sensor (base and front module)		AQR2546.. AQR2530NNW	1410
Wall-mounted KNX sensors		QMX3.P30 QMX3.P70	1602

Valve actuators
DC 0...10 V

Electric actuator, DC 0...10 V (for radiator valve)		SSA61..	4893
Electric actuator, DC 0...10 V (for 2 and 3 port valves/V..P45)		SSC61..	4895
Electric actuator, DC 0..10 V (for small valve 2,5 mm V..P47)		SSP61..	4864
Electric actuator, DC 0..10 V (for small valves 5.5 mm V..P45)		SSB61..	4891
Electric actuator, DC 0..10 V (for Combi-valve VPI46)		SSA61..	4893
Electromotoric actuator, DC 0...10 V (for valves 5.5 mm)		SAS61..	4581
Thermal actuator, DC 0...10 V (for small vlves and radiator valves)		STP63	4884

Damper actuators
DC 0...10 V and
3-position,
VAV compact
controllers

		GQD161.. GQD131..	4605
		GDB161.. GDB131..	4634
		GLB161.. GLB131..	
Damper actuators DC 0...10 V and 3-position		GMA161.. GMA131..	4614
		GEB161.. GEB131..	4621
		GCA161.. GCA131..	4613
		GBB161.. GBB131..	4626
		GIB161.. GIB131..	
VAV compact controller		GDB181.1E/3	3544
		GLB181.1E/3	

VAV compact controller KNX LTE-Mode	VAV compact controller for KNX LTE-Mode		GDB181.1E/KN	3547
			GLB181.1E/KN	
On/Off valve actuators AC 24 V	Electromotoric On/Off valve and actuator (only available in AP, UAE, SA and IN)		MVI../MXI..	4867
	Electromotoric On/Off actuator		SFA71..	4863
On/Off/PWM valve actuators AC 24 V*	Thermal actuator (for radiator valves)		STA73..	4884
	Thermal actuator (for small valves 2.5 mm)		STP73..	4884
3-position valve actuators AC 24 V	Electric actuator, 3-position (for radiator valves)		SSA81..	4893
	Electric actuator, 3-position (for small valves 2.5 mm V..P47)		SSP81..	4864
	Electric actuator, 3-position (for small valves 5.5 mm V..P45)		SSB81..	4891
	Electric actuator, 3-position (for CombiValves VPI46)		SSA81..	4893
	Electromotoric actuator, 3-position (for valves 5.5 mm)		SAS81..	4581

* With PWM control, it is not possible to ensure exact parallel running of more than one thermal actuator. If several actuators are controlled by the same room thermostat, preference should be given to motorized actuators with On/Off or 3-position control

Note

For more information about parallel operation and the maximum number of actuators that can be used, refer to the Data Sheets of the selected type of actuator and the following listing:

Maximum number of actuators in parallel operation with RDG400KN and RDG405KN:

- 6 actuators S..81 (3-position)
- 4 actuators ST..73 (On/Off)
- 4 actuators SFA.., MVI.., MXI.. (On/Off)
- 10 damper actuators G..16.. DC
- 6 damper actuators G..13.. (3-position)

2.6 Accessories

Description	Product No/ Stock No.	Data Sheet
KNX power supply unit 160 mA (Siemens BT LV)	5WG1 125-1AB02	--
KNX power supply unit 320 mA (Siemens BT LV)	5WG1 125-1AB12	--
KNX power supply unit 640 mA (Siemens BT LV)	5WG1 125-1AB22	--

3. Functions

3.1 Temperature and IAQ control (RDG405KN only)

3.1.1 Temperature control

General note: Parameters

Setting of the control parameters (P01, etc., mentioned throughout the document) is described in section 3.12.

Temperature control

The thermostat acquires the room temperature via built-in sensor, external room temperature sensor (QAA32) or external return air temperature sensor (QAH11.1), and maintains the setpoint by delivering actuator control commands to the heating and/or cooling equipment. The following control outputs are available:

- VAV box/air damper:
Modulating PI/P control with DC 0...10 V/3-position/KNX LTE-Mode
- Heating/cooling coil, radiator, electric heater:
Modulating PI/P control with 3-position/PWM/DC 0...10 V/On/Off control (2-position)

The switching differential or proportional band is 2 K for heating mode and 1 K for cooling mode (adjustable via P30 and P31).

The integral action time for modulating PI control is 5 minutes for the RDG400KN and 45 minutes for the RDG405KN (adjustable via P35).

Display

The display shows the acquired room temperature or the Comfort setpoint, selectable via P06. The factory setting displays the current room temperature. P04 is used to display the room temperature or setpoint in °F rather than °C as needed.

The acquired room temperature (built-in or external sensor) is also available as information on the bus.



Room temperature



- With automatic changeover or continuous heating/cooling, symbols / indicate that the system currently heats or cools (heating or cooling output activated)
- With manual changeover (P01 = 2), symbols / indicate that the system currently operates in heating or cooling mode. Thus, the symbols are displayed even when the thermostat operates in its neutral zone.
Symbols ◀ / ◀ indicate that the system currently heats or cools (heating or cooling output activated)

Concurrent display of °C and °F

Concurrent display of the current temperature or setpoint in °C and °F (P07 = 1) is possible on the thermostat.



Outside temperature via bus

The outside temperature can be displayed on the room thermostat by setting P07 = 2. This temperature value has only informative character. In LTE-Mode, the outside temperature can only be received on outside temperature zone 31.



Time of day via bus

Time of day via bus can be displayed on the room thermostat by setting P07 = 3 or 4. The display is either in 12- or 24-hour format. The information can be received from a Synco controller with time master

functionality or any other KNX device if the corresponding communication object is bound.

Note

When engineering with the ETS tool, the time of day can only be displayed on the RDG400KN when Synco group address 30/3/254 is loaded into the thermostat. For further details, refer to Basic Documentation [6], "Communication via KNX-bus for Synco 700", section "Engineering of big systems with ETS".

3.1.2 IAQ control (RDG405KN only)

General note

The IAQ function is used for air quality control on VAV applications. The function is achieved by controlling the air damper position according to the CO₂ level of the indoor air as well as the temperature.

Note that the air damper position is also controlled according to the temperature. It depends on which is higher, the temperature demand or the CO₂ level demand signal.

The function shall improve the indoor air quality by increasing the volumetric air flow or **VAV output signal respectively**.

- If the IAQ value of the room is below the preset CO₂ setpoint, the VAV output signal is controlled in accordance with minimum flow
- If the IAQ value exceeds the CO₂ setpoint, the VAV output signal is increased slowly until maximum flow is reached
- CO₂ control is activated in Comfort mode only.
In Economy and Protection mode, this function is disabled

Vmax is reached, when the IAQ value exceeds the preset CO₂ setpoint plus the CO₂ proportional band (SP+Xp).

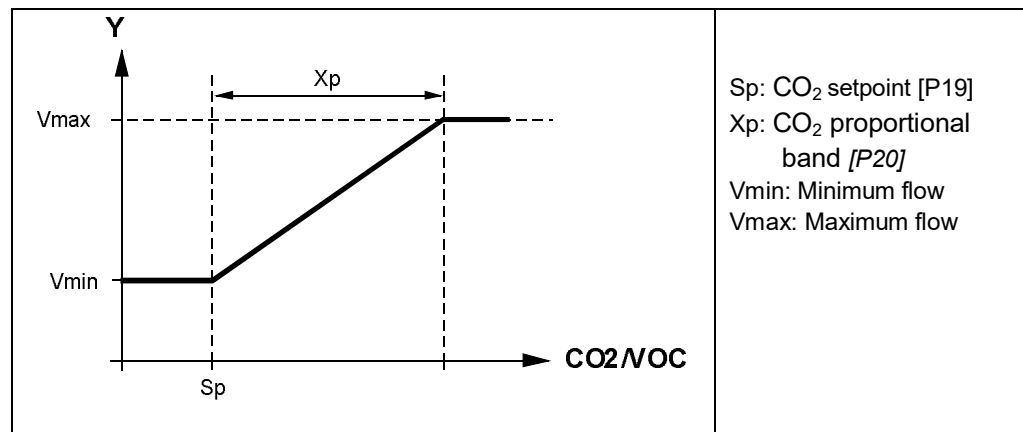

Parameter	Object	Description	Values	Factory setting
P19	CO ₂ (VOC) setpoint	CO ₂ (VOC) setpoint	OFF(0)...5000 ppm	1000
P20	CO ₂ (VOC) P-band Xp	Proportional band between Vmin and Vmax	10...2000 ppm	400

Notes

- P19 can be set up to 5000 ppm but the external analog sensor is limited to 2000 ppm. If there is a need to measure above 2000 ppm, a KNX sensor is required to send the value with the respective object
- P19 = OFF switches the IAQ function off
- The IAQ value is acquired either via a locally connected CO₂ or VOC sensor or a CO₂ value via bus (e.g. KNX)

Important note for KNX LTE:

IAQ control does not influence in any way the energy demand air, heating or cooling (in LTE-Mode).

IAQ control – priority CO₂ control

- If the local CO₂ sensor input is configured, the thermostat uses the CO₂ value from the locally connected sensor. Otherwise, the CO₂ value available on KNX is used for CO₂ control
- In case the local CO₂ sensor is configured, but the value is not valid (value <100 ppm), the thermostat uses the CO₂ value via KNX bus. If both CO₂ sources do not deliver a valid value, the CO₂ function is disabled
- S-Mode has a higher priority than LTE-Mode
- If the CO₂ value comes from the bus, the local (DC 0...10 V) value is not sent on the bus
- Receiving and sending the same S-Mode object is not allowed
- The thermostat receives the CO₂ LTE object when the corresponding geographical zone is selected



The "Fresh air" symbol appears on the screen as soon as the actual CO₂ value exceeds the CO₂ setpoint.

Display: IAQ function

The IAQ level can be shown on the LCD. 3 choices are available:

- P07 = 0 No display
- P07 = 6 CO₂ concentration shown as ppm
- P07 = 7 CO₂ concentration shown in the form of symbols

Parameter	Name	Factory setting	Range
P07	Additional display information	0 (RDG405KN only)	0 = --- (no display) 1 = °C and °F 2 = outside temperature (via bus) 3 = time of day (12 h) (via bus) 4 = time of day (24 h) (via bus) 6 = CO ₂ concentration [ppm] 7 = CO ₂ symbols

Selection P07 = 6: CO₂ concentration in ppm

The CO₂ concentration is shown on the second line with the ppm symbol.

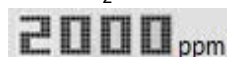

Minimum display: 100 ppm
Maximum display: 5000 ppm

Selection P07 = 7: CO₂ symbols

The CO₂ concentration is shown on the second line with "+++, ++-, +--". This parameter can be useful when a VOC sensor is installed.

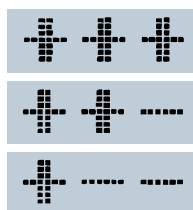

GOOD: Current CO₂ concentration is below the CO₂ setpoint

OKAY: Current CO₂ concentration is within the CO₂ Xp (proportional band)

POOR: Current CO₂ concentration is above the CO₂ setpoint + Xp (proportional band)

When the thermostat is programmed with a CO₂ display (ppm or symbols) and no values are available (no sensor on U1 or no value on KNX), or when the value received is below 100 ppm, the thermostat displays "---"

IAQ control using a VOC sensor

The VOC sensor can only be connected to the local analog input U1.

Since the thermostat does not distinguish between CO₂ or VOC sensor, the IAQ function and the thermostat's behavior are the same as for applications with a CO₂ sensor.

For this application, we suggest to keep the default values of setpoint [P19] and proportional band [P20]. Later, based on the occupant's feeling, these parameters can be readjusted for optimum room comfort.

3.2 Operating modes

The thermostat's operating mode can be influenced in different ways (see below). Specific heating and cooling setpoints are assigned to each operating mode.

The thermostat sends the effective room operating mode on the bus.

The following operating modes are available:



Room operating mode:
State

Auto Timer 

In Auto Timer mode, the room operating mode is commanded via bus. Auto Timer mode is replaced by Comfort mode when no time schedule via bus is present.

Comfort 

In Comfort mode, the thermostat maintains the Comfort setpoint. This setpoint can be defined via P8, P9 and P10. It can be locally adjusted via the rotary knob or the bus.

KNX presence detector (RDG405KN)

The thermostat switches to Comfort mode when the presence detector (local or via KNX) is active (room occupied).*

Economy 

The setpoints (less heating and cooling than in Comfort mode) can be defined via P11 and P12.

The thermostat switches to Economy mode when ...

- the operating mode button is pressed (only possible if P02 = 2),
- Economy is sent via bus,



Room operating mode:
Window state
(RDG400KN)

- an operating mode switchover contact (e.g. keycard contact, presence detector, window contact) is active (for RDG400KN); the contact can be connected to digital input D1 or multifunctional input X1; set P38/P42 to 3 (P02 is irrelevant) *) (for RDG400KN)
- "Window state" is sent via bus, e.g. from a KNX switch or a KNX presence detector (P02 is irrelevant) *) (for RDG400KN)



Note

- *) Operating mode switchover: Only one input source must be used, either local input X1-D1 or the KNX bus. User operations are ineffective and **OFF** is displayed if the operating mode switchover contact is active, or if "Window state" is sent via bus

Protection

In Protection mode, the system is ...

- protected against frost (factory setting 8 °C, can be disabled or changed via P65),
- protected against overheating (factory setting OFF, can be enabled or changed via P66).

No other operating mode can be selected locally if Protection mode is commanded from the time schedule via bus (e.g. from RMB795).  and  are displayed.

KNX room operating mode: Window state (RDG405KN)

The thermostat switches to Protection mode when ...

- the operating mode button is pressed,
- Protection mode is sent via bus,
- the window contact on the RDG405KN is active (open window),
- "Window state" is sent to the RDG405KN via bus (e.g. from a KNX switch) *)

Note

- *) For details regarding the operating mode switchover contact (RDG40..KN), window contact (RDG405KN) and presence detector (RDG405KN), refer to section [3.2.1](#).

3.2.1 Different ways to influence the operating mode

Source for change of operating mode



ACS

The operating mode can be influenced by different interventions.

The source of the effective room operating mode state can be monitored using the "Cause" diagnostic data point in the ACS tool, OZW772 web server.

Source	Description	Value of DP "Cause"
Local operation via left button	<ul style="list-style-type: none"> Operating mode is not Auto Timer No time schedule via bus 	Room operating mode selector (preselection)
	<ul style="list-style-type: none"> Temporary Comfort extension is active 	"Timer" function
	<ul style="list-style-type: none"> Operating mode switchover contact (RDG400KN) 	Room operating mode contact
	<ul style="list-style-type: none"> Window contact (RDG405KN) 	Window switch
	<ul style="list-style-type: none"> Presence detector (RDG405KN) 	Presence detector
 Room operating mode	<ul style="list-style-type: none"> Window state sent via bus (RDG400KN) 	Room operating mode contact
	<ul style="list-style-type: none"> Window state sent via bus (RDG405KN) 	Window switch
	<ul style="list-style-type: none"> Presence detector sent via bus (RDG405KN) 	Presence detector
	<ul style="list-style-type: none"> Time schedule available via bus → local operating mode is set to "Auto Timer" Time schedule sends Protection mode via bus → operating mode cannot be changed locally 	Time switch





Priority of operating mode interventions

The following table shows the priorities of different interventions.

Lower number means higher priority.

Priority	Description	Remark
①	Commissioning	In parameter setting mode (highest priority), you can always command an operating mode independent of all other settings or intervention via bus and local input.
②	Protection mode via bus from time schedule	Protection mode sent by a time schedule has priority 2. It cannot be overridden by the user nor by an operating mode switchover contact.
③	Operating mode switchover contact (RDG400KN)	If the contact is closed, the operating mode changes to Economy. This overrides the operating mode on the thermostat.
③	Window contact (RDG405KN)	If the contact is closed, the operating mode changes to Protection. This overrides the operating mode on the thermostat.
③	"Window state" via bus	"Window state" sent via bus has the same effect as the operating mode switchover contact (RDG400KN) or local window contact (RDG405KN).
		Note: Only one input source must be used, either the local input X1-D1 or the KNX bus.
④	Operating mode button	The user can change the operating mode using the operating mode button.
④	Operating mode via bus	The operating mode can be changed via bus.
④	Temporary extended Comfort mode via operating mode button	The operating mode can be temporarily set from Economy to Comfort by pressing the operating mode button, if ... – Economy mode was sent via bus, – extended Comfort mode period >0 (P68)
		The last intervention wins, either locally or via bus.
④	Time schedule via bus	The operating mode sent via bus can be overridden by all other interventions. Exception: Protection mode has priority 2.
④	Presence detector (RDG405KN)	If the contact is closed (room occupied), the operating mode changes to Comfort. This overrides the operating mode on the thermostat. An open contact (room unoccupied) sets the thermostat back to the previous operating mode.
④	Presence detector via bus (RDG405KN)	"Presence detector" sent via bus has the same effect as the local presence detector. Note: Only one input source must be used, either the local input X1-D1 or the KNX bus.

Auto Timer mode with time schedule via bus 

If a time schedule via bus is present (e.g. from the central control unit), Auto Timer mode  is active. In that case, the thermostat changes automatically between Comfort and Economy mode according to the time schedule via bus. The display shows the Auto Timer mode symbol  along with the symbol for the effective room operating mode (Comfort  or Economy ). By pressing the operating mode button, another operating mode can be selected.

Behavior when bus sends new operating mode

Each time the time schedule sends a new operating mode (switching event), the operating mode of the thermostat is set back to Auto Timer mode. This is to ensure that the room temperature is maintained according to the time schedule.

Precomfort via bus











If the time schedule sends Precomfort mode, this mode changes either to Economy (factory setting) or Comfort (selectable via P88).

Behavior when bus sends Protection

No intervention is possible neither by the user nor by an operating mode switch-over contact, if Protection mode is set by the time schedule. **OFF** blinks on the display when the user presses a button.

Availability of Economy mode

The operating mode can be selected locally via the operating mode button. The behavior of the operating mode button (user profile) can be defined via P02 (factory setting is P02 = 1).

P02	Without time schedule	With time schedule via bus	Description
1	 → 	 → 	<ul style="list-style-type: none"> Switching manually between 2 modes, Economy is not available (factory setting) Suited for hotel guest rooms or commercial buildings If a time schedule via bus is available, Comfort mode can be temporarily extended (see below)
2	 →  → 	 →  →  → 	<ul style="list-style-type: none"> Switching manually between 3 modes Suited for homes and rooms where manual switching to Economy mode is desired

Operating mode switchover contact (window contact) (RDG400KN)

The thermostat can be forced into Economy mode (e.g. when a window is opened, when a presence detector signals "No one present", when the keycard of a hotel room is withdrawn, etc). The contact can be connected to digital input D1 (or multifunctional input X1). Set P42 (P38) to 3.

If the operating mode switchover contact is active, pressing the left button will show **OFF** (blinking).

Window contact (RDG405KN)

The thermostat is forced into Protection mode when the window is open. The contact can be connected to multifunctional input X1 or digital input D1. Set P38 or P42 to 3. User operations are ineffective and **OFF** displays if the window contact is active.



Room operating mode:
Window state

The function is also available via the KNX signal "Window state", e.g. from a KNX switch or a KNX presence detector.



Presence detector
(RDG405KN)

Note: Only one input source must be used, either local input X1-D1 or the KNX bus. User operations are ineffective and **OFF** is displayed if the operating mode switch-over contact is active, or if "Window state" is sent via bus.

The operating mode can be changed to Comfort or Economy based on room occupancy (room occupied or unoccupied, via presence detector or keycard).

Time schedule via bus	Presence detector behavior
Comfort mode	<ul style="list-style-type: none"> Whenever the presence detector is activated or deactivated, Comfort mode is maintained
Economy mode	<ul style="list-style-type: none"> Whenever the presence detector is activated, the operating mode changes to Comfort Whenever the presence detector is deactivated, the operating mode changes to Economy (with Auto mode)
Protection mode	<ul style="list-style-type: none"> Presence detector has no impact on the operating mode
Not available	<ul style="list-style-type: none"> Whenever the presence detector is activated, the operating mode changes to Comfort Whenever the presence detector is deactivated, the operating mode changes to Economy

Notes

- When the time switch changes to Economy, but the presence detector is still active, Comfort mode is maintained until the presence detector becomes inactive
- The contact (e.g. a card reader) can be connected to multifunctional input X1 or digital input D1 (set P38 or P42 to 10) or the occupancy is sent via bus from a KNX presence detector (only one input source must be used, either local input X1-D1 or the KNX bus)

Temporary timer to extend Comfort mode

Comfort mode can be temporarily extended (e.g. working after business hours or on weekends) when the thermostat is commanded to Economy mode by a central time switch, operating mode switchover via KNX or via local input X1-D1.

The operating mode button switches the operating mode back to Comfort for the period preset via P68.

Press the operating mode button again to stop the timer.

The following conditions must be fulfilled:

- Mode selection via operating mode button is set to "Protection-Auto" (P02 = 1) and P68 (extend Comfort period) is greater than 0
- The time schedule via bus is Economy or operating mode switchover is active

During the temporary Comfort mode extension, symbol  appears.

If P68 (extend Comfort period) = 0, extended Comfort cannot be activated; pressing the left button switches the thermostat to Protection mode.

Timer for extension of presence/absence





The effective room operating mode can be forced temporarily into Comfort or Economy/Protection mode. The time period is adjusted via the rotary knob:

- Extend presence: Set the device to Comfort mode for the selected time period
- Extend absence: Set the device to Economy/Protection mode for the selected time period





To activate the function, keep the left button pressed and, within 3 seconds, turn the rotary knob ...

- clockwise for extended presence,
- counterclockwise for extended absence.

The rotary knob adjusts the time period:







- Extend presence: 0:00...+9:30 in steps of 30 minutes; symbol  appears
 - Extend absence: 0:00...-9:30 in steps of 30 minutes; symbol  or  appears
- During the extended presence/absence period, the sandglass symbol  appears.

Function if no time schedule is received via bus

User profile for operating mode (selected via P02)	Operating mode when activating function	Function	Operating mode during function	Operating mode at the end of function
P02 = 1:  	Comfort	Extension	Comfort	Protection
	Comfort	Absence	Protection	Comfort
P02 = 2:   	Comfort or Economy	Extension	Comfort	Economy
	Comfort or Economy	Absence	Economy	Comfort

Note Extension/absence functions are not available in Protection mode.

Function with time schedule via bus

User profile for operating mode (selected via P02)	Operating mode when activating function	Function	Operating mode during function	Operating mode at the end of function
P02 = 1:   	Auto or Comfort	Extension	Comfort	Auto
	Auto or Comfort	Absence	Protection	Auto
P02 = 2 →    	Auto, Comfort or Economy	Extension	Comfort	Auto
	Auto, Comfort or Economy	Absence	Economy	Auto

Note Extension/absence functions are not available in Protection mode.

3.2.2 Communication examples

The following examples show 2 typical applications of a central time schedule in connection with local control of the room operating mode.

The room operating mode in rooms 1...2 of a building is determined by the time schedule. Window contacts are fitted in all rooms.

The following conditions are specified:

The rooms are used and controlled by the time schedule as follows:

- Night setback from 17:00 to 08:00 (Economy)
- Protection from 20:00 to 06:00
- Lunch break from 12:00 to 13:00 (Precomfort)

The substitution (P88) for Precomfort via bus is set on the thermostat as follows:

- Room 1: Comfort (1)
- Room 2: Economy (0)

Example 1 (RDG400KN) Operating mode switchover

In **room 1**, the window is opened briefly, once in the morning, once in late afternoon and once at night (1). Only the opening in the morning has a direct impact on the effective room operating mode.

During lunch break, the time schedule changes to Precomfort. Comfort mode is maintained as set via parameter "Transformation Precomfort" (P88 = 1).

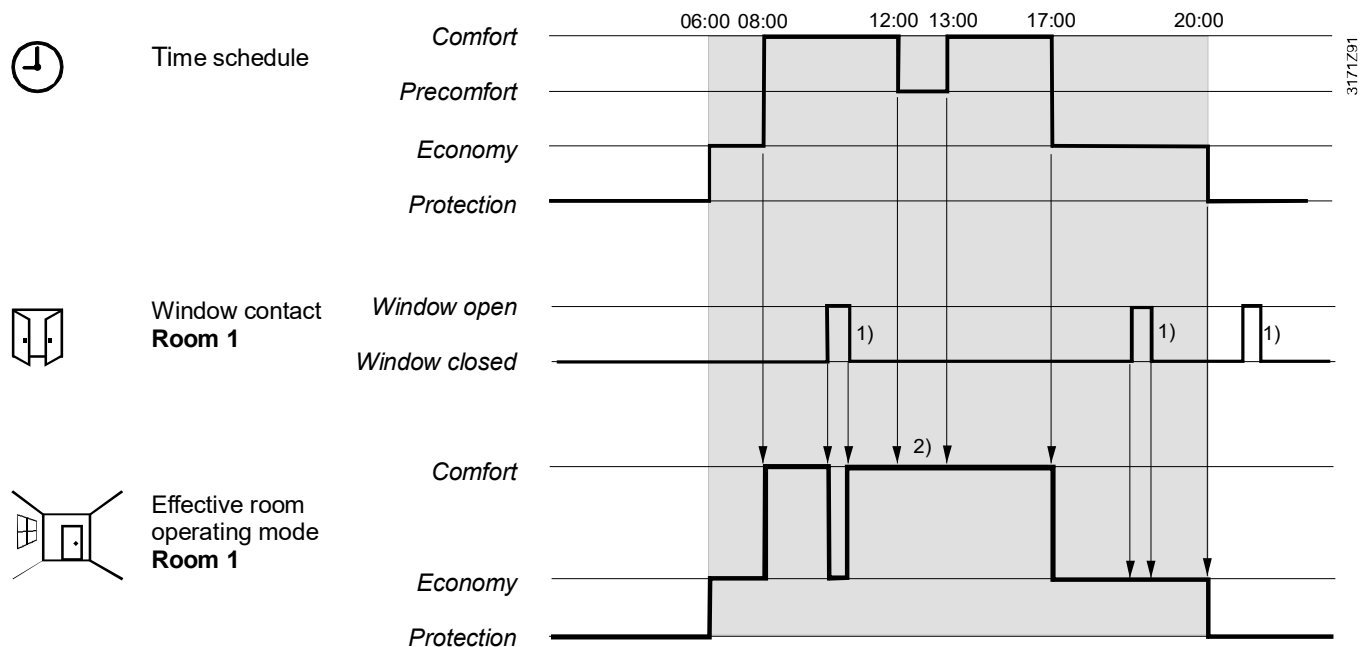

Example 2 (RDG400KN)

Interaction of user operation (operating mode button) and central time schedule

In **room 2**, the window is opened briefly, once in the morning and once at night (1). Only the opening in the morning has a direct impact on the effective room operating mode.

With the operating mode button, the operating mode can be changed between OFF and Auto or temporary Comfort extension respectively.

- During lunch break, the time schedule changes to Precomfort. The operating mode of the thermostat changes to Economy as set by parameter "Transformation Precomfort" (P88 = 0) (6)
- During lunch break, the user changes the operating mode to Comfort (temporary Comfort extension) by pressing the operating mode button (2). At 13:00, the timer is reset due to mode change of the central time schedule
- In the afternoon, the user switches the thermostat off by pressing the operating mode button (3). At 17:00, the user setting is reset to Economy by the time schedule
- At 19:30, the user again extends the Comfort mode (4). At 20:00, the timer is reset by the time schedule
- After 20:00, pressing the operating mode button has no effect, as the central time switch sets the thermostat to Protection mode (5)

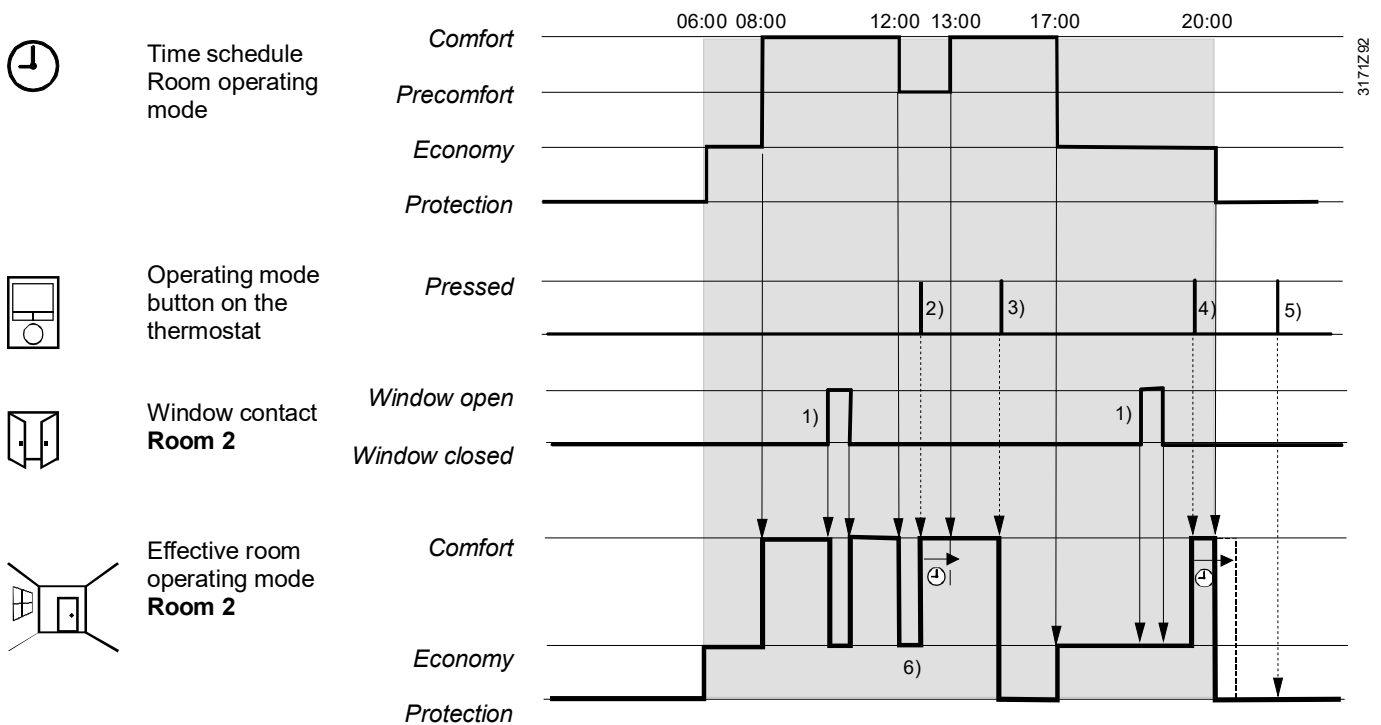

3171292

Example 3 (RDG405KN)

Application for "Window contact", "Presence detector" and "Central time schedule"

In **room 3**, the time schedule switches to Comfort mode between 13:00 and 17:00.

- In the morning, as soon as presence is detected, the operating mode switches to Comfort (1)
 - The users open the window for a short time and the operating mode switches to Protection (2)
 - In the afternoon, the central time schedule sets the Comfort mode from 13:00 to 17:00 (3)
 - After 17:00, the room is still occupied and Comfort mode is maintained (occupancy via presence detector) (4)
 - The users open the window and exit the room for a short time. The operating mode switches to Protection as long as the window is open (5)
 - As soon as the room is unoccupied, the thermostat switches to Economy (6)
- After this time period, the occupancy detected by the presence detector has no effect, and the central time schedule sets the thermostat to Protection mode (7).

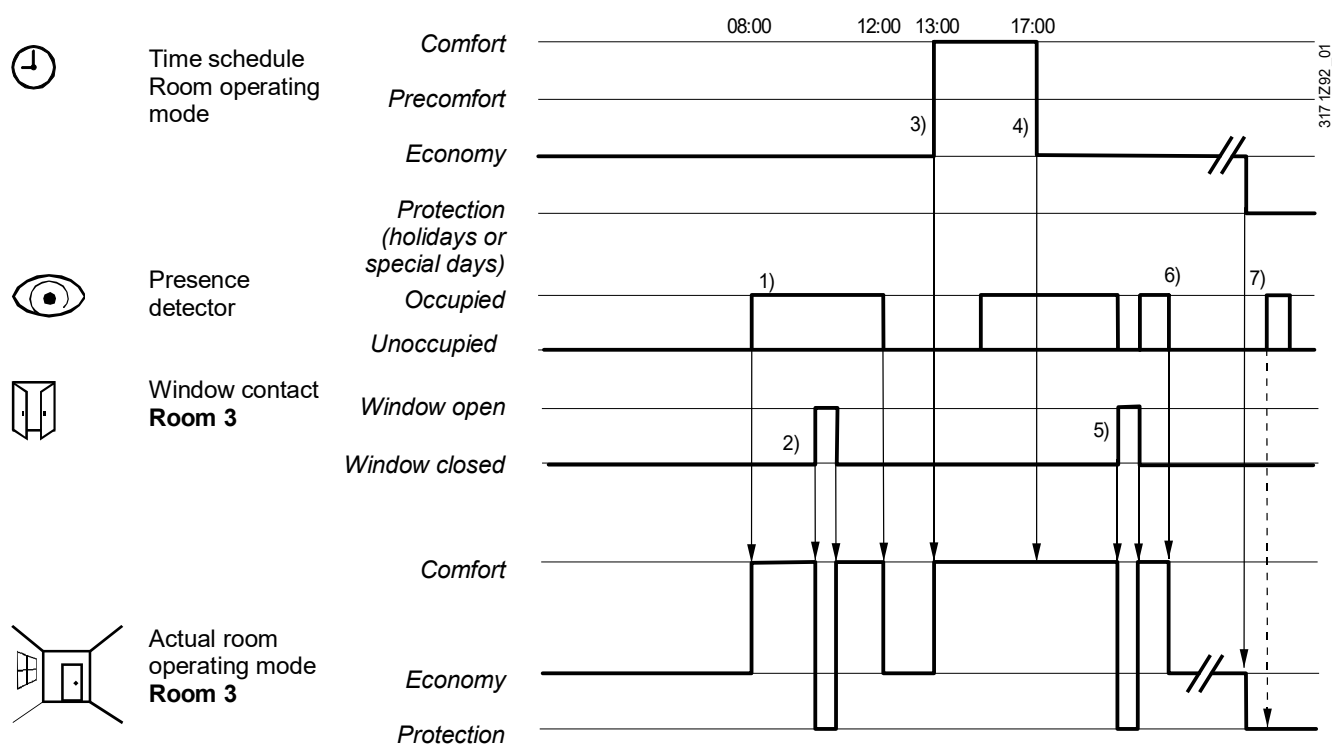

3.3 Room temperature setpoints

3.3.1 Description

Comfort mode

The factory setting for the Comfort basic setpoint is **21 °C** and can be changed in the thermostat's EEPROM via P08 or via bus with communication object "Comfort basic setpoint". The last intervention always wins.



For **applications with heating and cooling sequence and a dead zone greater than 0 °C**, the basic Comfort setpoint always remains the reference for the heating sequence.

However, the Comfort setpoint is either the heating setpoint or the cooling setpoint according to the active sequence (heating or cooling). See also the table in section 3.3.2 and hysteresis behavior, section 3.6.2.

Setpoint adjustment

The current setpoint also appears on the RDG..'s display. It can be adjusted via the rotary knob, or via bus from a remote device like a touch panel, operating unit, etc. The last intervention always wins.

The thermostat also shows the symbol of the active sequence while the rotary knob is turned:

- Setpoint and heating symbol () show that the Comfort setpoint "Heating" is being adjusted
- Setpoint and cooling symbol () show that the Comfort setpoint "Cooling" is being adjusted

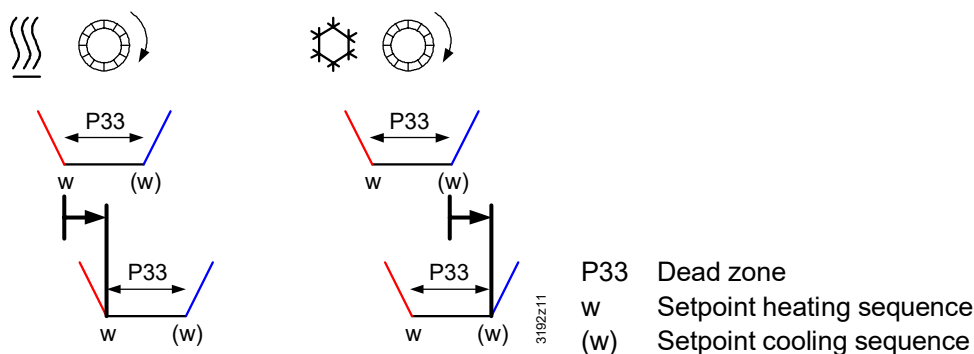

Adjusting the Comfort setpoint via rotary knob causes a shift of the dead zone. Although only **one** setpoint shows on the RDG..'s display, both setpoints are shifted by the same value.

Temporary setpoint

If the "Temporary setpoint" function is enabled via P69, the Comfort setpoint adjusted via the rotary knob, or via bus, is set back to the Comfort basic setpoint stored in P08 when the operating mode changes.

Setpoint limitation

For comfort or energy saving purposes, the setpoint setting range can be limited to minimum (P09) and maximum (P10).

P09 < P10 (comfort concept)

- If the minimum limit **P09 is set lower** than the maximum limit P10, both heating and cooling are adjustable between these 2 limits
- The customer adjusts the desired setpoint and the thermostat controls the room temperature accordingly

Example

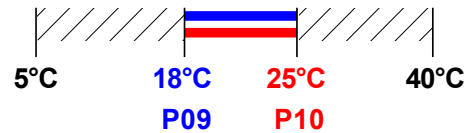

Cooling setpoint adjustable: 18...25 °C
Heating setpoint adjustable: 18...25 °C

P09 ≥ P10
(energy saving concept)

- If the minimum limit **P09 is set higher** than the limit P10, ...
 - the setting range of the cooling setpoint is from **P09...40 °C** in place of 5...40 °C,
 - the setting range of the heating setpoint is from **5...P10 °C** in place of 5...40 °C.

This allows the user to limit the maximum heating setpoint and the minimum cooling setpoint. This concept helps save energy costs.

- For **heating OR cooling applications** ^{*)}:
 - The thermostat operates with the setpoint of the active sequence:
In heating mode, the heating setpoint is active and adjustable via the rotary knob. In cooling mode, the cooling setpoint is active and adjustable via the rotary knob
 - Switching from the heating to the cooling setpoint and vice versa occurs when the room temperature reaches the adjusted limitation (P09 or P10) of the **inactive** sequence (e.g. the thermostat is in the heating sequence and runs with the heating setpoint). When the room temperature reaches P09, the thermostat switches to cooling mode and runs with the cooling setpoint as long as the room temperature does not drop below P10

Example

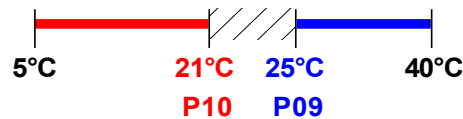

Cooling setpoint adjustable: 25...40 °C
Heating setpoint adjustable: 5...21 °C

Economy mode ☾

Use P11 and P12 to adjust the Economy mode setpoints.
The heating setpoint is factory-set to **15 °C**, and the cooling setpoint to **30 °C**.

Protection mode ⬆️

Use P65 and P66 to adjust the Protection mode setpoints.
The heating setpoint is factory-set to **8 °C** (frost protection) and to **OFF** for cooling.

Caution ⚠️

If a setpoint (Economy or Protection) is set to OFF, the thermostat does not control the room temperature in the corresponding mode (heating or cooling). This means no protective heating or cooling function and thus risk of frost in heating mode or risk of overtemperature in cooling mode!

The Economy setpoints are accessible at the Service level (P11, P12), the Protection setpoints at the Expert level (P65, P66).

3.3.2 Setting and readjusting setpoints

Room temperature setpoints can be ...

- set during commissioning,
- readjusted during operation.



Comfort basic setpoint
 Comfort setpoint
 Economy heating setpoint ⁴⁾
 Economy cooling setpoint ⁴⁾

The source can be ...

- the local HMI,
- a tool,
- a central control unit.

The thermostat stores the setpoints ...

- in EEPROM in the form of parameters,
- in the runtime memory.

The table below shows the interrelations:

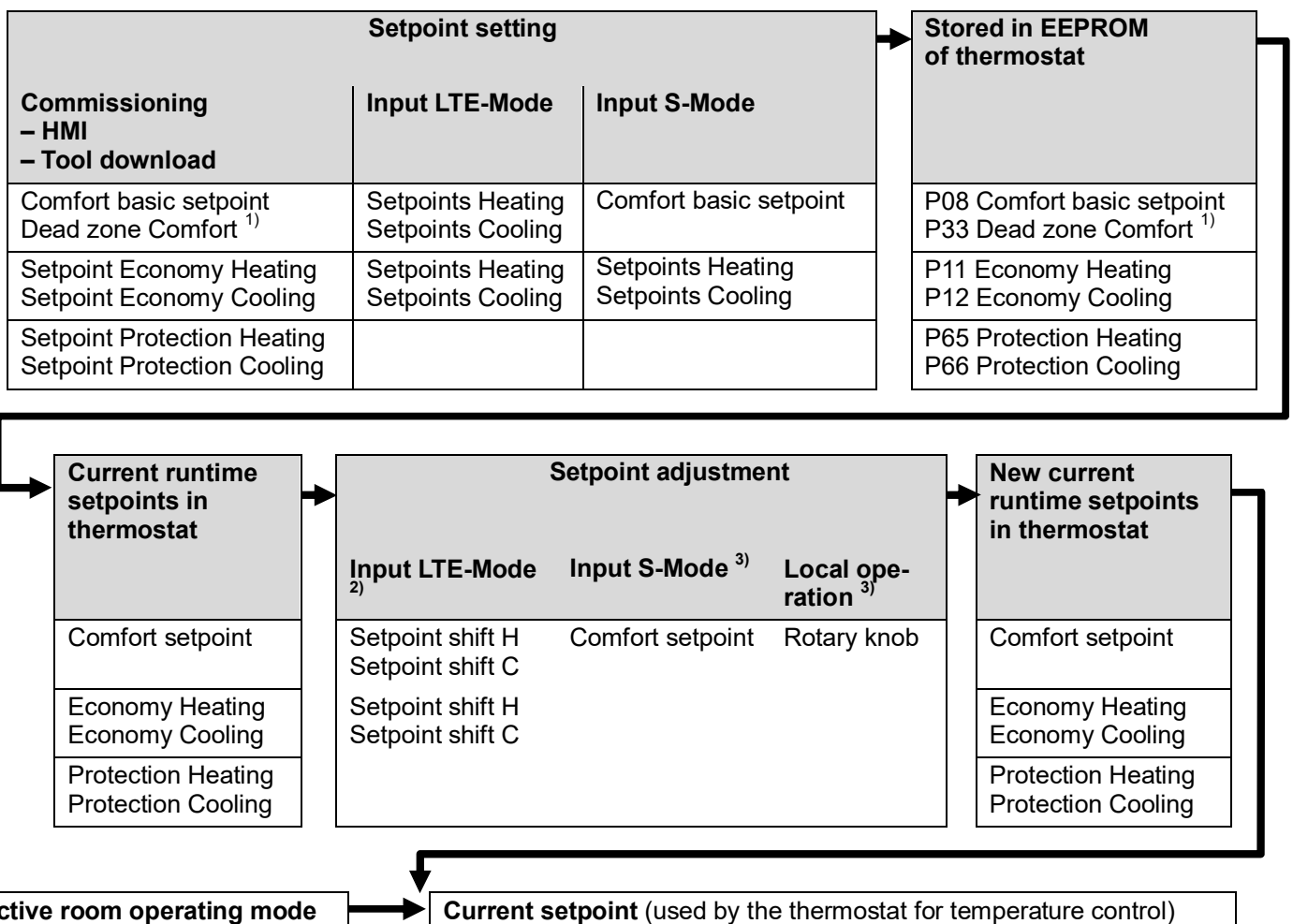

- 1) Only required for heating AND cooling applications (see section 3.6.9)
- 2) The shift is added to the local shift (LTE-Mode only)
- 3) The last intervention wins, either S-Mode input or local operation
- 4) To display the S-Mode objects of the Economy heating and cooling setpoint (P11, P12), set the control parameter "Room temperature: Economy setpoints" to **as group object** in the ETS tool



Current setpoint

The current setpoint (used by the thermostat for temperature control) is available on the bus for use in the central control unit.

General notes

- The supported communication objects differ in LTE- and S-Mode
- Changes via the local HMI or via KNX have the same priority (last always wins)
- Adjusting the Comfort basic setpoint resets the runtime Comfort setpoint to the basic setpoint

Notes on setpoint adjustment (LTE-Mode with Synco only)





- Central setpoint shift is used for summer/winter compensation in particular
- Setpoint shift does not affect the setpoints stored in P08, P11, P12 and P33
- Local shift and central shift are added together
- Applies only to Comfort and Economy setpoints; Protection setpoints are not shifted centrally
- The resulting (current) setpoint heating and cooling is limited by the Protection setpoint; if the Protection setpoint is OFF, minimum 5 °C and maximum 40 °C are used
- The resulting setpoints for cooling and heating of the same operating mode have a minimum distance of 0.5 K between them
- The result of local and central shift, together with the room operating mode, is used by the thermostat for temperature control (current setpoint)

3.4 Applications overview

The room thermostats support the following applications, which can be configured using the DIP switches at the rear of the unit or a commissioning tool.

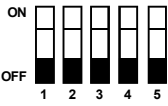
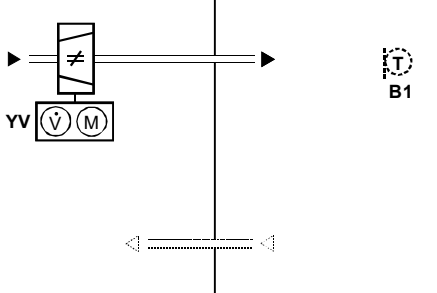
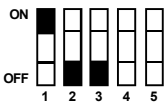
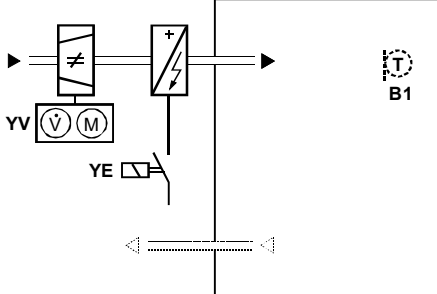
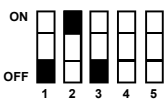
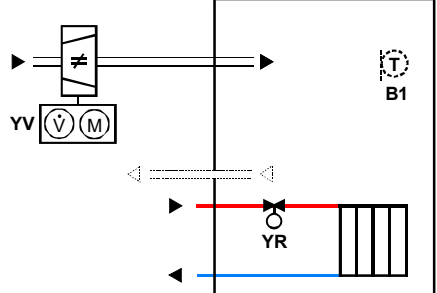
DIP switches 1...5 must be set to OFF (remote configuration, factory setting) to select an application via commissioning tool. In this case, the output signal type needs to be set in the ACS tool as well.

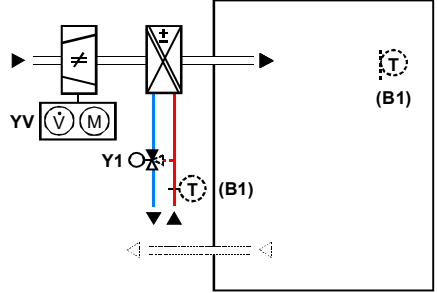
The tool offers the applications printed in bold text (basic applications).

Application	DIP switches
Remote configuration Via commissioning tool (factory setting) <ul style="list-style-type: none"> • Synco ACS • ETS 	ON  OFF
Single-duct <ul style="list-style-type: none"> • DC 0...10 V damper actuator (P47 = 0) • 3-position damper actuator (P47 = 1) • VAV compact controller KNX LTE mode 	ON  OFF
Single-duct with electric heater <ul style="list-style-type: none"> • DC 0...10 V damper actuator and On/Off, PWM or 3-position electric heater (P47 = 0) • 3-position damper actuator and DC 0...10 V electric heater (P47 = 1) • VAV compact controller KNX LTE-Mode and electric heater 	ON  OFF
Single-duct and radiator/floor heating <ul style="list-style-type: none"> • DC 0...10 V damper actuator and On/Off, PWM or 3-position radiator (P47 = 0) • 3-position damper actuator and DC 0...10 V radiator (P47 = 1) • VAV compact controller KNX LTE-Mode and radiator 	ON  OFF
Single-duct heating and cooling coil <ul style="list-style-type: none"> • DC 0...10 V damper actuator and On/Off, PWM or 3-position heating and cooling (P47 = 0) • 3-position damper actuator and DC 0...10 V heating and cooling (P47 = 1) • VAV compact controller KNX LTE-Mode and heating/cooling coil 	ON  OFF

Notes

- P47 is used to change the air damper output from DC 0...10 V (factory setting) to 3-position
- P46 is used to change the valve output from On/Off (factory setting) to PWM

- DIP switch 4 is used to change output of Y10 from DC 0...10 V to DC 10...0 V
- DIP switch 5 is used to change the valve output from On/Off to 3-position

3.4.1 Applications with supply and extract air

Applications with supply and extract air can be realized in the following ways:

Master/slave function between the VAV compact controllers for supply and extract air

- Control signal from RDG.. and VAV air damper position (for primary air optimization) are transmitted via KNX bus
- Communication settings (geographical zone, air distribution zone) of the RDG.. and the GDB..KN need to be set accordingly. Reference see [18] and section 3.10.13.
- This application requires VAV compact controllers with KNX LTE-Mode

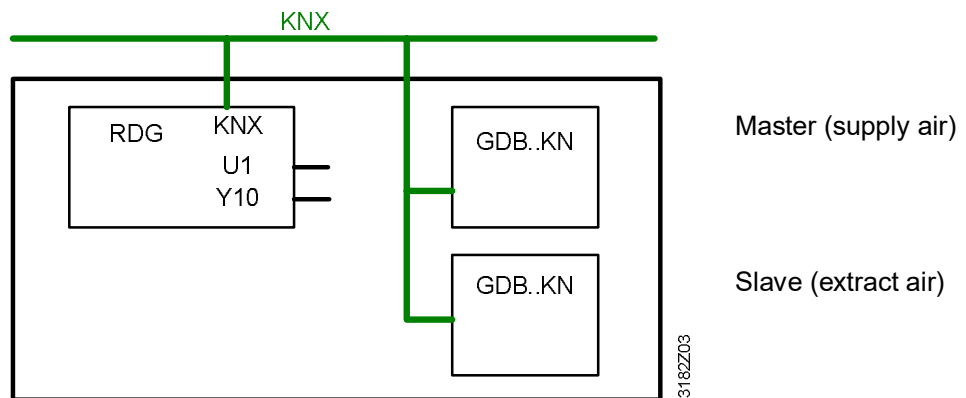

Parallel connection of Y10 control signal and air damper position feedback via U1

- RDG.. output Y10 controls **both** VAV compact controllers for supply air and extract air
- The current air damper position of **one** VAV compact controller is transmitted to input U1 and via KNX for primary air optimization
- This application requires analog VAV compact controllers (noncommunicating)

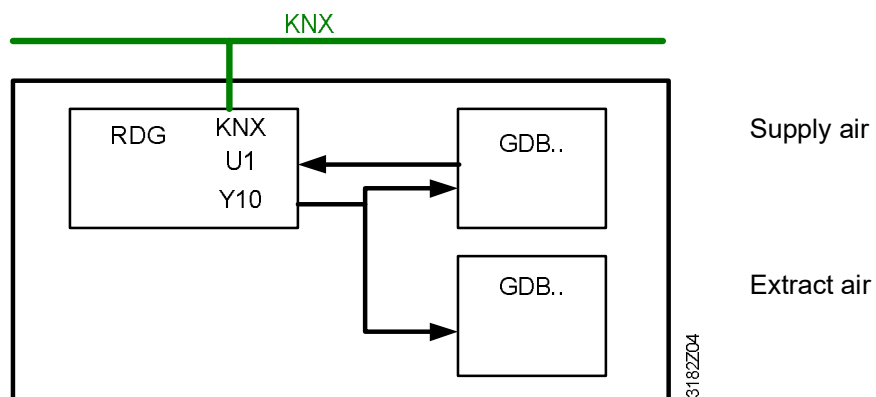

3.5 Additional functions

Air heating/cooling changeover



Supply air temperature

The supply air temperature sent by the primary controller indicates whether cold or warm air is supplied.

The controller determines the necessity to open or close the air damper according to the supply air temperature, the room temperature setpoint and the current room temperature.

If no supply air temperature is available via bus, air changeover is cooling per default.

With "Single-duct" applications, changeover can also be accomplished via a local multifunctional input X1-D1 (P38, P42).

Only one input source must be used, either local input X1-D1 or the KNX, and parameter "Control sequence" must be set to automatic heating/cooling changeover (P01 = 3).

For functionality of the local changeover input, see below (also refer to section 3.8).

Water heating/cooling changeover



Heating/cooling changeover

With applications "Single-duct with heating/cooling coil", changeover information of the heating/cooling coil can be received either via bus or the local multifunctional input X1-D1 (P38, P42).

Only one input source must be used, either local input X1-D1 or the KNX, and parameter "Control sequence" must be set to automatic heating/cooling changeover (P01 = 3) (also refer to section 3.8).

In the absence of the required heating/cooling information from the bus (e.g. due to problems with data communication, power failure, etc.), the thermostat operates in the last valid operating mode (heating or cooling).

Automatic heating/cooling changeover via changeover sensor

If a cable temperature sensor (QAH11.1 + ARG86.3) is connected to X1, and P38 = 2, the water or supply air temperature acquired by the sensor is used to change over from heating to cooling mode, or vice versa.

- When the **water/air temperature** is above 28 °C (adjustable via P37), the thermostat changes over to **heating mode**. Heating mode is maintained until the temperature falls below 16 °C (adjustable via P36)
- When the **water/air temperature** is below 16 °C (adjustable via P36), the thermostat changes over to **cooling mode**. Cooling mode is maintained until the temperature rises above 28 °C (P37)
- If the water/air temperature is between the 2 changeover points immediately after power-up (inside the hysteresis), the thermostat starts in the previous mode

The water/air temperature is acquired at 30-second intervals and the operating state is updated accordingly.

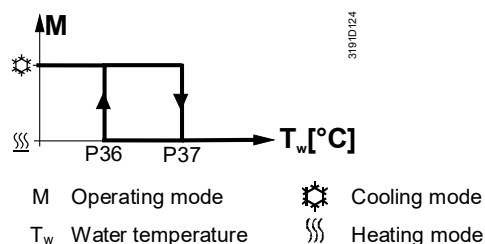

Changeover switch

The QAH11.1 cable temperature sensor for automatic heating/cooling changeover can be replaced by an external switch for manual remote changeover.

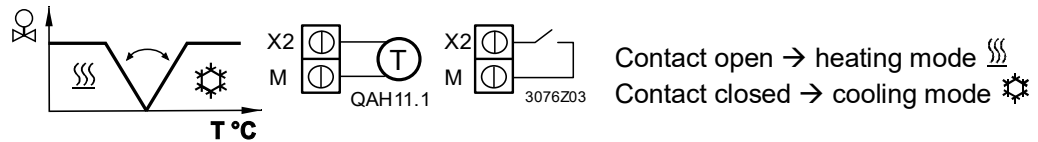

The sensor or switch can be connected to input X1 or D1 (switch only), depending on the commissioning of the inputs (P38, P42) (also refer to section 3.8).

Manual heating/cooling changeover

- Manual heating/cooling changeover means selection via changeover button on the thermostat by repeatedly pushing the button until the required mode is shown on the display (automatic changeover takes place via bus or an external sensor/switch connected to X1 or D1)
- If manual heating/cooling changeover is commissioned (P01 = 2), heating/cooling mode cannot be changed via bus/changeover sensor/switch; it maintains the last mode as selected locally via the button

External/return air temperature sensor

The thermostat acquires the room temperature via built-in sensor, external room temperature sensor (QAA32) or external return air temperature sensor (QAH11.1) connected to multifunctional input X1.

Input X1 must be commissioned accordingly (see section 3.8).

Floor temperature limitation function

The floor temperature should be limited for 2 reasons: Comfort and protection of the floor.

The floor temperature sensor connected to multifunctional input X1 acquires the floor temperature. If the temperature exceeds the parameterized limit (P51), the heating valve is fully closed until the floor temperature drops to a level 2 K below the parameterized limit.

This function is factory-set to OFF (disabled).

Input X1 must be commissioned accordingly (P38 = 1) (see section 3.8).

Recommended values for P51

Living rooms:

Up to 26 °C for long-time presence, up to 28 °C for short-time presence.

Bathrooms:

Up to 28 °C for long-time presence, up to 30 °C for short-time presence.

The table below shows the relation between parameter, temperature source and temperature display:

Parameter P51	External temp. sensor available	Source for display of room temperature	Output control according to ...	Floor temp. limit function
OFF	No	Built-in sensor	Built-in sensor	Not active
OFF	Yes	External temp. sensor	External temp. sensor	Not active
10...50 °C	No	Built-in sensor	Built-in sensor	Not active
10...50 °C	Yes	Built-in sensor	Built-in sensor + limit by external sensor	Active

Dewpoint monitoring

Dewpoint monitoring is essential to prevent condensation on the chilled ceiling. It helps avoid associated damage to the building.

A dewpoint sensor with a potential-free contact is connected to multifunctional input X1 or D1. If there is condensation, the cooling valve is fully closed until no more condensation is detected, and the cooling output is disabled temporarily.

The condensation symbol is displayed during temporary override and the fault "Condensation in room" is sent via bus.

The input must be commissioned accordingly (P38, P42) (see section 3.8).

Button lock

If the "Button lock" function is enabled via P14, the buttons will be locked or unlocked by pressing the right button for 3 seconds.

If "Auto lock" is configured, the thermostat will automatically lock the buttons 10 seconds after the last adjustment.

3.6 Control sequences

3.6.1 Sequences overview (setting via P01)

The mode of the control sequence can be set via P01. Depending on the selected application, it will have an impact either on the air or water sequence.

On all applications the changeover of the air sequence can be effected via the supply air temperature sent by the primary controller.

The available sequences depend on the type of application:

Parameter	P01 = 0	P01 = 1	P01 = 2	P01 = 3			
Sequence					c/o signal on X1-D1	c/o signal via bus	Supply air temp. via bus
Available for basic application: ↓	Heating	Cooling ↘ = heating sequence for electric heater/radiator	Manually select heating or cooling sequence (using the button on the thermostat)	Automatic heating/cooling changeover via external water/air temperature sensor or remote switch			
Single-duct	✓	✓	✓	✓	✓ ¹⁾		✓ ¹⁾
Single-duct and electric heater	-	-	-	-			✓ ¹⁾
Single-duct and radiator	-	-	-	-			✓ ¹⁾
Single-duct and heating/cooling coil	✓	✓	✓	✓	✓ ²⁾	✓ ²⁾	✓ ¹⁾

1) Changeover air

2) Changeover water (heating/cooling coil)

Note

For the relation between setpoints and sequences, refer to section 3.6.9.

Air sequence vs. water sequence

Application	Parameter P01 influences the ...
Single-duct	Air sequence
Single-duct and electric heater	--

Single-duct and radiator	--
Single-duct and heating/cooling coil	Water sequence

3.6.2 Hysteresis: Behavior of heating and cooling

- The control sequences heating and cooling depend on the heating and cooling setpoints and the room temperature
- The thermostat remains in the heating sequence as long as the room temperature does not reach the cooling setpoint
- The thermostat remains in the cooling sequence as long as the room temperature does not reach the heating setpoint

The value of the output and the sequence as a function of the room temperature is shown in the following diagram in the case of a heating and cooling system:

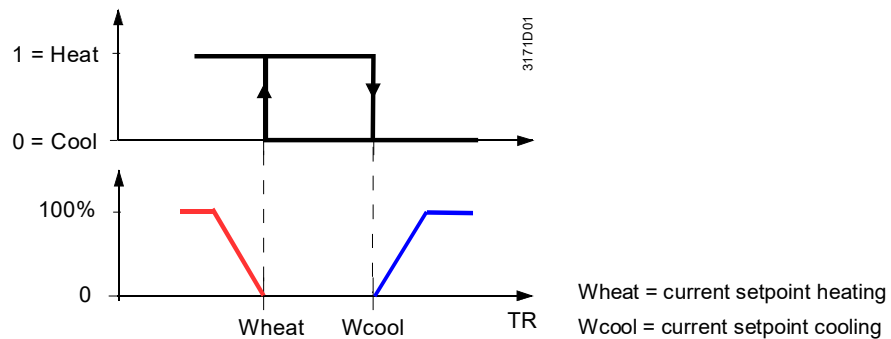

3.6.3 Application mode



Application mode

The behavior of the thermostat can be influenced by a building automation and control system (BACS) via bus using the **Application mode** command. With this signal, cooling and/or heating activity can be enabled or disabled. Application mode is supported in LTE- and S-Mode. The RDG..KNX room thermostats support the following commands:

#	Application mode	Description	Control sequence enabled
0	Auto	Thermostat automatically changes between heating and cooling	Heating and/or cooling
1	Heat	Thermostat is only allowed to heat	Heating only
2	Morning warm-up	If Morning warm-up is received, the room should be heated up as fast as possible (if necessary). The thermostat only allows heating	Heating only
3	Cool	Thermostat is only allowed to provide cooling	Cooling only
4	Night purge	If Night purge is received, the room should be aired with cool outside air if necessary. The thermostat opens the air damper and does not heat/cool with the coils or the electric heater. Function will be ended by any operation on the thermostat	Open air damper fully if night purge condition is valid ¹⁾
5	Pre-cool	If Pre-cool is received, the room should be cooled down as fast as possible (if necessary). The thermostat only allows cooling	Cooling only
6	Off	Thermostat is not controlling the outputs, which means all outputs go to off or 0%	Neither heating nor cooling
8	Emergency heat	The thermostat should heat as much as possible. The thermostat only allows heating	Heating only
9	Fan only	All control outputs are set to 0% and the air damper is fully opened. Function will be ended by any operation on the thermostat	Open air damper fully

With all other commands, the thermostat behaves like in Auto mode, i.e. heating or cooling according to demand.

1) Conditions for the "Night purge" function:

RDG400KN	<p>The function is activated when ...</p> <p>A: No supply air temperature via KNX is available: Current room temperature > Comfort setpoint cooling</p> <p>B: The supply air temperature via KNX is available (or air changeover is made by the supply air temperature via KNX): Current room temperature > supply air temperature and current room temperature > Comfort setpoint cooling</p>
RDG405KN	<p>Function is activated when:</p> <p>A: No supply air temperature is not available: Current room temperature > Calculate Comfort heating setpoint plus 1K</p> <p>B: Supply air temperature is available Current room temperature > Calculate Comfort heating setpoint plus 1K and the supply air temperature is plus 3K < Current room temperature.</p> <p>Function is deactivated when: The current room temperature < Calculate Comfort heating setpoint or The supply air temperature plus 2K > Current room temperature</p>



The state (heating or cooling) of the thermostat can be monitored with the ACS tool (diagnostic value "Control sequence"). The last active mode is displayed when the thermostat is in the dead zone or temperature control is disabled.

Heating OR cooling

On single-duct applications, the control sequence state is determined by the application mode (see section 3.6.2) and by the state of the heating/cooling changeover signal (via local sensor or bus), or fixed according to the selected control sequence (P01 = heating (0)/cooling (1)).

Application mode (via bus)	State changeover/continuous heating or cooling	Control sequence state (ACS diagnostic value)
Auto (0)	Heating	Heating
	Cooling	Cooling
Heat (1), (2), (8)	Heating	Heating
	Cooling	Heating
Cool (3), (5)	Heating	Cooling
	Cooling	Cooling
Night purge (4), Fan only (9)	Heating	Heating
	Cooling	Cooling

Heating AND cooling

On applications "Single-duct with electric heater/radiator/heating/cooling coil", the control sequence state depends on the application mode and the heating/cooling demand.

Application mode (via bus)	Heating/cooling demand	Control sequence state (ACS diagnostic value)
Auto (0)	Heating	Heating
	No demand	Heating/cooling depending on last active sequence
	Cooling	Cooling
Heat (1), (2), (8)	Heating	Heating
	No demand	Heating
	Cooling	Heating
Cool (3), (5)	Heating	Cooling
	No demand	Cooling
	Cooling	Cooling
Night purge (4), Fan only (9)	No temperature control active	Heating/cooling depending on last active sequence

3.6.4 Minimum and maximum air volume



The factory setting for minimum and maximum air volume is 0/100% respectively. These values can be changed via P63/P64. Alternatively, Vmin and Vmax can be set directly on the VAV compact controller (G..B181.E/KN).

If Vmin is greater than 0, a minimum air flow Vmin is ensured in both Comfort and Economy mode.

In Protection mode (or Economy with setpoint = OFF), Vmin is fixed to 0.

Comfort or Economy mode

Protection mode: Vmin always = 0

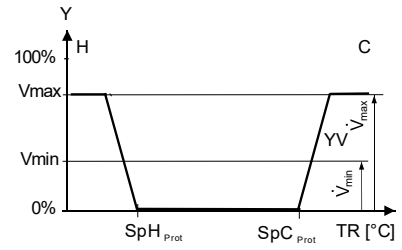
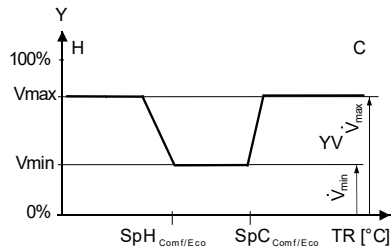

3.6.5 Single-duct applications

On single-duct applications, the thermostat controls an actuator (air damper, VAV system, valve, etc.) ...

- in heating/cooling mode with changeover (automatically or manually),
- in heating only mode, or
- cooling only mode.

Cooling only is factory-set (P01 = 1).

The output signal for the air flow can be limited to a minimum and maximum value if required (see section 3.4.1).

Modulating control: 3-position or DC 0...10 V, KNX LTE-Mode

The diagrams below show the control sequence for modulating PI control.

Heating only (P01 = 0)

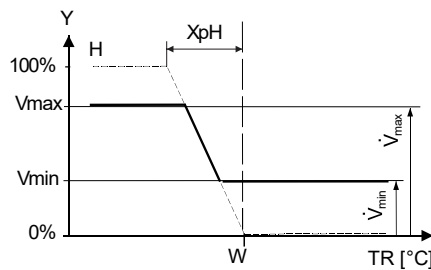

Cooling only (P01 = 1)

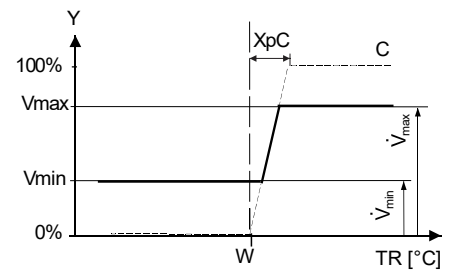

Changeover (P01 = 2, 3)

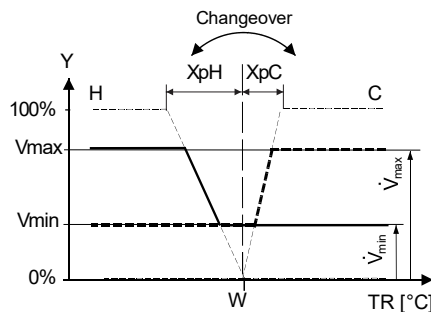

T[°C] Room temperature
w Room temperature setpoint
Y Control command **Actuator**

XpH Proportional band "Heating"
XpC Proportional band "Cooling"
Vmin Minimum limitation for output
Vmax Maximum limitation for output

Notes

- The diagrams only show the PI controller's proportional part

- Switching between heating and cooling depends on the setpoints and the room temperature (see section 3.6.2)

Setting the sequence and the control outputs

Refer to sections 0, 3.6.1 and 3.7.

3.6.6 Single-duct applications with electric heater

Caution

General rule: In case of insufficient air flow, the thermostat cannot protect the electric heater against overtemperature. For this reason, the heater **must** be equipped with a separate safety device (thermal cutout).

On single-duct applications with electric heater, the thermostat controls a valve plus an electric heater. P01 is not available.

The output signal for the air flow can be limited to a minimum and maximum value if required using P63 and P64. On applications "Single-duct with electric heater", the minimum value of P63 is overridden, so that the air flow never drops below 10% while the electric heater is in operation.

Electric heating,
active in cooling mode

The air flow starts to rise depending on the acquired room temperature, the current supply air temperature (if available) and the setpoint.
The electric heater receives an **On** command when the acquired room temperature drops below the setpoint (= setpoint for electric heater).

Digital input "Enable
electric heater"

Remote enabling/disabling of the electric heater is possible via input X1 or D1 for tariff regulations, energy savings, etc.
Input X1 or D1 must be commissioned accordingly (P38, P42) (see section 3.8).



Enable electric heater

The electric heater can also be enabled/disabled via bus.

Note

If input "Enable electric heater" is used via bus, the function **must not** be assigned to a local input X1 or D1.
On start-up of the controller and if the primary controller sends the information that the primary fan is off, the thermostat disables the electric heater (see section 3.10.9).

Fan overrun time

To avoid overheating of an electric heater when switched off, the air flow signal of Vmin must be maintained for a preset "Fan overrun time" (P54, factory setting 60 seconds).
In connection with a Synco primary controller it will be ensured that the primary fan keeps running during the fan overrun time (also refer to section 3.10.10).

Sequences

On/Off electric heater RDG400KN

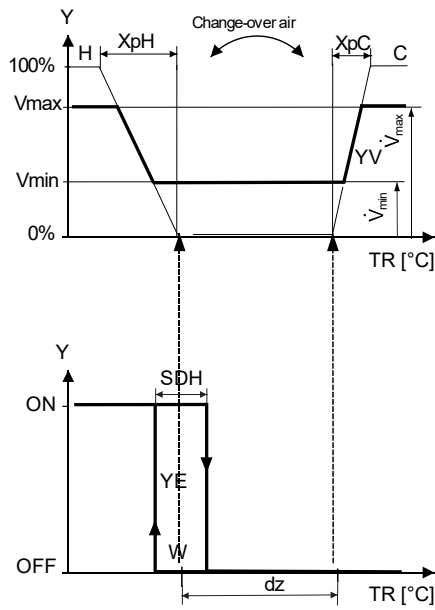

Modulating electric heater RDG400KN

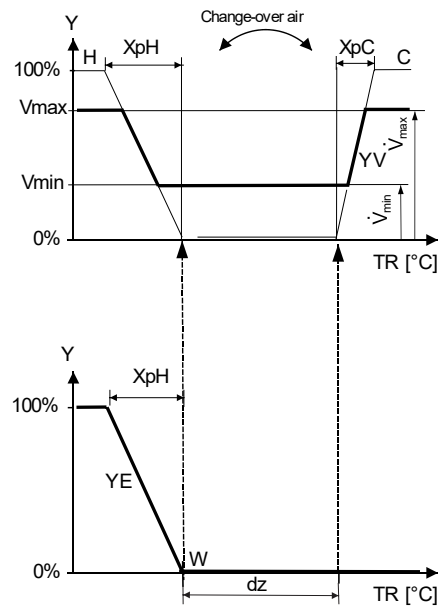

On/Off electric heater RDG405KN

Modulating electric heater RDG405KN

1-stage heating: Changeover air is recognized as cooling or neutral

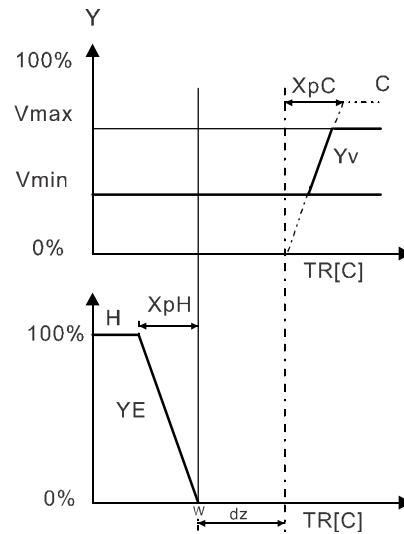
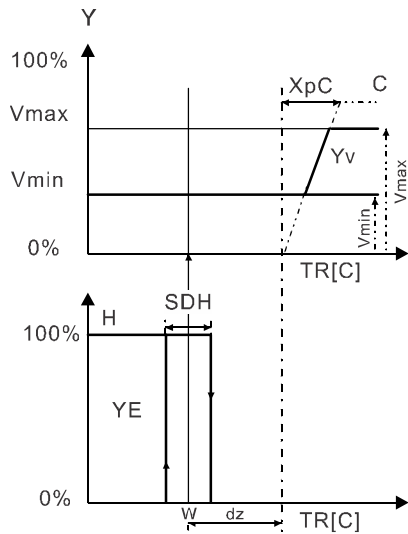

2-stage heating: Changeover air is recognized as heating

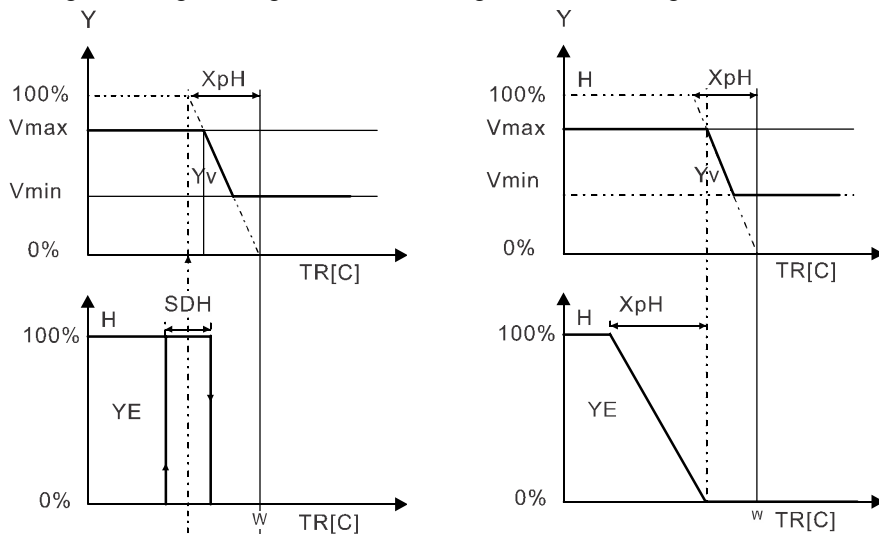

Without a valid bus signal for changeover air, the air volume is only increased for cooling:

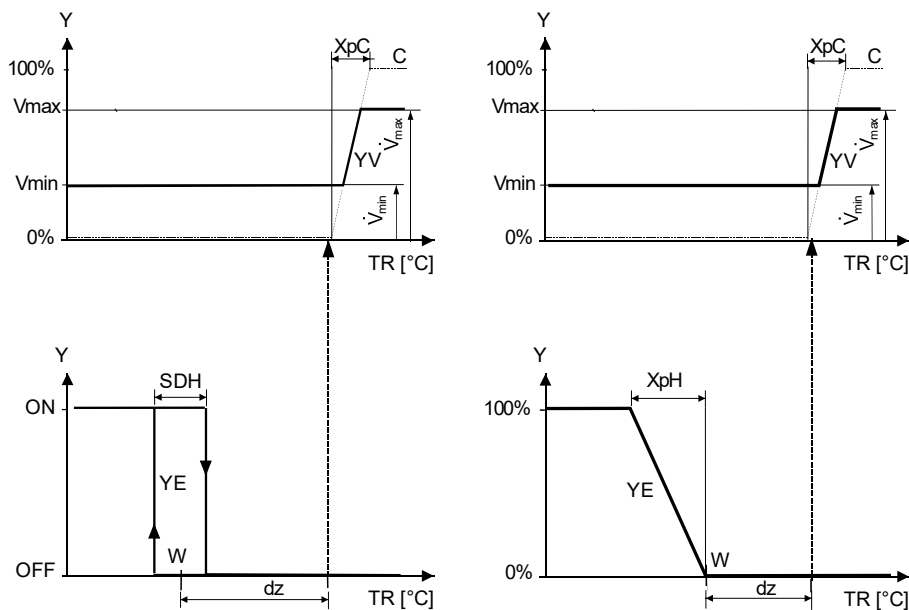

Y	Output signal
TR	Room temperature
W	Effective setpoint Comfort
H	Heating sequence
C	Cooling sequence
YV	Volume flow rate
YE	Electric heater
XpH	Proportional band heating
XpC	Proportional band cooling
Vmin	Minimum volume output
Vmax	Maximum volume output
SDH	Switching differential heating (P30)

Notes

- The diagrams only show the PI thermostat's proportional part
- Switching between heating and cooling depends on the setpoints and the room temperature (see section 3.6.2)

Setting the sequence and the control outputs

Refer to sections 0, 3.6.1 and 3.7.

3.6.7 Single-duct applications with radiator or floor heating

On single-duct applications with radiator or floor heating, the thermostat controls an air damper or a VAV compact controller plus a valve actuator. P01 is not available.

The output signal for the air flow can be limited to a minimum and maximum value if required (see section 3.4.1).

Radiator, active in cooling mode

The air flow starts to rise depending on the acquired room temperature, the current supply air temperature (if available) and the setpoint.

The radiator receives an **On** command when the acquired room temperature drops below the setpoint (= setpoint for radiator).

Note

"Setpoint for radiator" is limited by the parameter "Maximum heating setpoint" (P10).

Floor heating

The radiator sequence can also be used for floor heating.

The "Floor temperature limitation" function is described on page 32.

Sequences

2-position radiator/floor heating

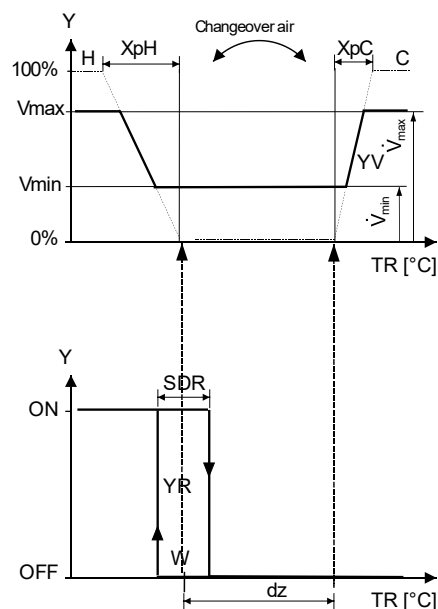

Y Output signal
 TR Room temperature
 W Effective setpoint Comfort
 H Heating sequence
 C Cooling sequence
 YV Volume flow rate
 YR Radiator/floor heating

Modulating radiator/floor heating

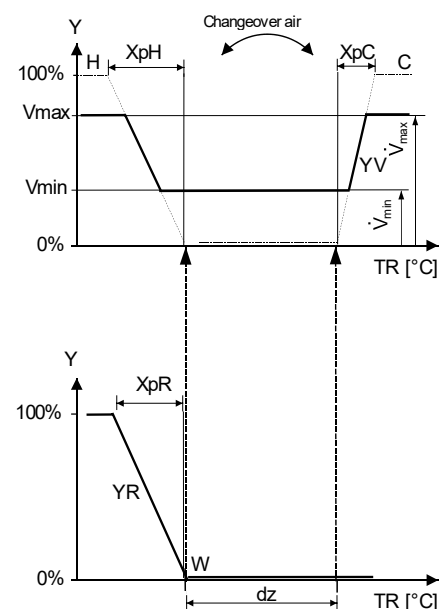

XpH Proportional band heating
 XpC Proportional band cooling
 Vmin Minimum volume output
 Vmax Maximum volume output
 SDR Switching differential radiator

Without a valid bus signal for changeover air, the air volume is only increased for cooling:

2-position radiator/floor heating

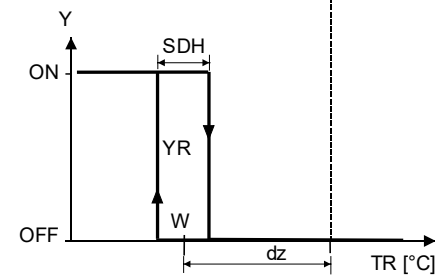
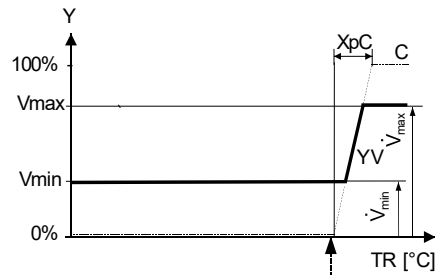

Y Output signal
 TR Room temperature
 W Effective setpoint Comfort
 H Heating sequence
 C Cooling sequence
 YV Volume flow rate
 YR Radiator/floor heating

Modulating radiator/floor heating

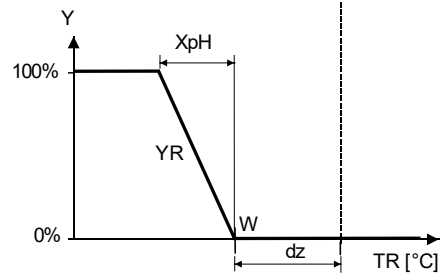
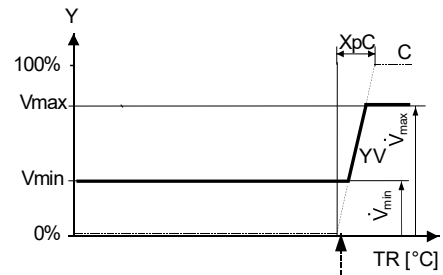

XpH Proportional band heating
 XpC Proportional band cooling
 Vmin Minimum volume output
 Vmax Maximum volume output
 SDH Switching differential heating

Notes

- The diagrams only show the PI controller's proportional part
- Switching between heating and cooling depends on the setpoints and the room temperature (see section 3.6.2)

Setting the sequence and the control outputs

Refer to sections 0, 3.6.1 and 3.7.

3.6.8 Single-duct applications with heating/cooling coil

On single-duct applications with heating/cooling coil, the thermostat controls an actuator (air damper, VAV system, etc.) plus a heating/cooling water coil.

The output signal for the air flow can be limited to a minimum and maximum value if required (see section 3.4.1).

The thermostat controls the reheating/cooling water valve either in heating/cooling mode with changeover (automatically or manually), heating only, or cooling only. Cooling only is factory-set (P01 = 01).

The air flow starts to rise depending on the acquired room temperature, the current supply air temperature (if available) and the setpoint.

Water coil valve in cooling mode

If the room temperature is above the setpoint for cooling (w), the valve receives an **Open** command and the air flow signal starts to rise to maintain the room temperature setpoint.

Water coil valve in heating mode

If the room temperature drops below the setpoint for heating (w), the valve receives an **Open** command.

Control sequence

The diagrams below show the control sequence for modulating PI control in Comfort mode.

2-position heating/cooling coil

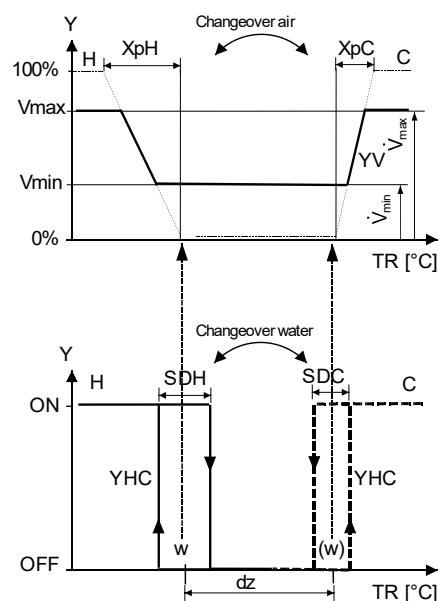

Y Output signal
 TR Room temperature
 w Comfort setpoint when heating sequence active
 (w) Comfort setpoint when cooling sequence active
 H Heating sequence
 C Cooling sequence
 YV Volume flow rate

Modulating heating/cooling coil

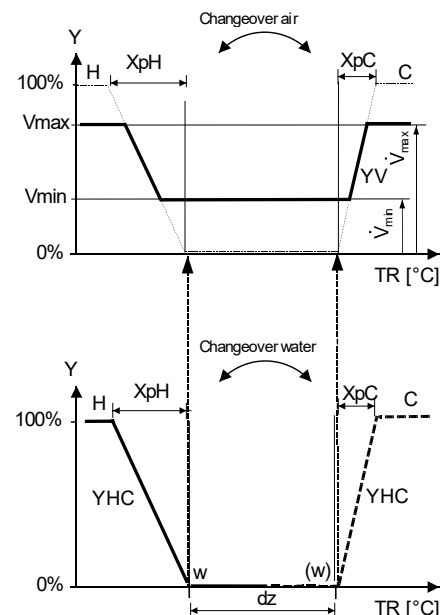

XpH Proportional band heating
 XpC Proportional band cooling
 Vmin Minimum volume output
 Vmax Maximum volume output
 SDH Switching differential heating

Without a valid bus signal for changeover air, the air volume is only increased for cooling.

2-position heating/cooling coil

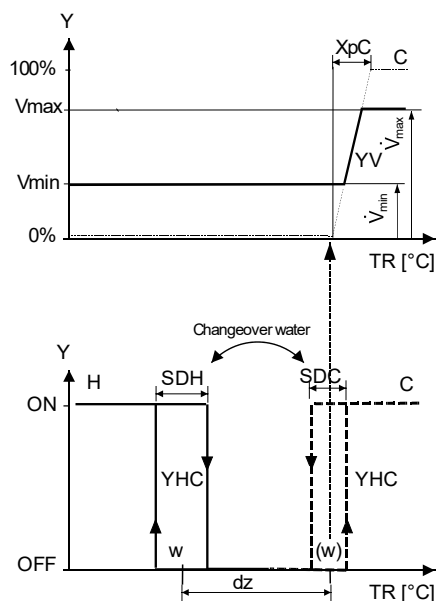

Modulating heating/cooling coil

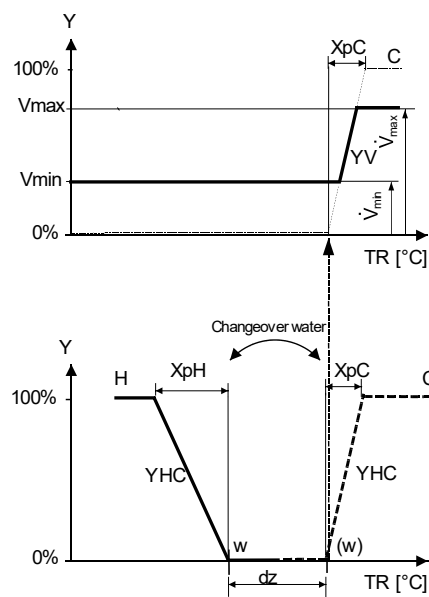

Y Output signal
 TR Room temperature
 w Comfort setpoint when heating sequence active
 (w) Comfort setpoint when cooling sequence active
 H Heating sequence
 C Cooling sequence
 YV Volume flow rate

XpH Proportional band heating
 XpC Proportional band cooling
 Vmin Minimum volume output
 Vmax Maximum volume output
 SDH Switching differential heating

Notes

- The diagrams only show the PI controller's proportional part
- Switching between heating and cooling depends on the setpoints and the room temperature (see section 3.6.2)

Setting the sequence and the control outputs

Refer to sections 0, 3.6.1 and 3.7.

3.6.9 Setpoints and sequences

Comfort setpoint (w) is in the currently active heating or cooling sequence.

Changeover air

- If the supply air temperature is available (via KNX), the air flow may also increase when the room temperature is below the heating setpoint
- If no supply air temperature is available, the sequence for air flow control is cooling only

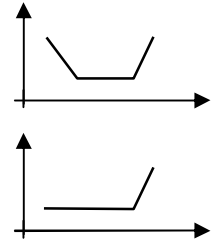

Economy, Protection

The setpoints for Economy and Protection mode are below the Comfort setpoints (heating) and above the Comfort setpoints (cooling). They can be set via P11, P12 (Economy) and P65, P66 (Protection).

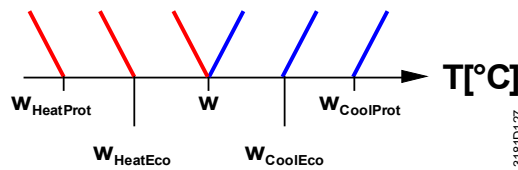

Application	Comfort mode		Economy/Protection mode	
	Heating	Cooling	Heating	Cooling
Single-duct 1)				
Single-duct with electric heater/radiator/floor heating				
Single-duct with heating/cooling coil				
	Heating and cooling		Heating and cooling	
SW < 1.24/ device index < C only: Single-duct with electric heater/radiator/ floor heating				

W = setpoint in Comfort mode

Y = air/water sequence

$W_{HeatEco/Prot}$ = setpoint heating in Economy or Protection mode

T = room temperature

$W_{CoolEco/Prot}$ = setpoint cooling in Economy or Protection mode

The dead zone can be adjusted via P33.

- 1) Single-duct: A dead zone can be set also. In this case, the diagram is the same as for single-duct with electric heater

3.6.10 Applications with external AQR sensor or QMX room operator unit (RDG405KN)

The equipment combination is for use in commercial buildings, offices, schools, museums, shops, etc.

Advantages of equipment combination	AQR/QMX sensor	
	LTE-Mode	S-Mode
a) Sensor can be installed in the optimal place for temperature acquisition	✓	✓
b) Unauthorized people cannot change settings on sensors installed in the room	✓	✓
c) The HVAC equipment and measurement point (T, CO ₂) are far apart (e.g. in large spaces). Installing the thermostat near the equipment and the sensor on the measurement point reduces wiring costs and increases control accuracy	✓	✓
d) Several RDG.. room thermostats can operate with one room temperature and/or CO ₂ value (in large spaces)	X	✓
e) AQR/QMX sensor is more appropriate for interior design	✓	✓

With sensor AQR25.. or QMX3..0

The AQR25.. and QMX3.P.. sensors can deliver room temperature and CO₂ values to the RDG405KN.

The RDG405KN and the sensors use LTE-Mode (KNX) communication. To exchange information (room temperature or CO₂ values), both devices must have the same geographical zone, apartment and room (A.R.1, where "A" is the value of P82 and "R" is the value of P83 of the RDG405KN). This equipment combination works on a 1-to-1 basis. Values cannot be delivered from the sensor to several RDG405KN room thermostats.

For applications in S-Mode, the objects for room temperature of the RDG405KN must be set to **Receive** in ETS. The thermostat then works with the values acquired by the sensor. Default setting **Transmit** indicates that the RDG405KN provides the local room temperature via bus. One sensor can deliver data to several thermostats.

Note

For commissioning with ACS V10 software: Set the same geographical zone on the RDG.. and the Siemens KNX sensor AQR..

- In the corresponding geographical/time switch zone, the RDG405KN is shown under "Slaves"
- The IAQ KNX sensor (e.g. AQR2570) must be assigned as "Networked devices" of the RDG405KN

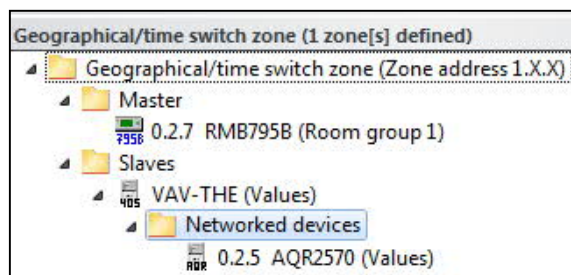

3.7 Control outputs

3.7.1 Overview

Different control output signals are available depending on the configuration of the thermostat via DIP switches 4 and 5, and P46 and P47.

Control output Product No.	Modulating DC 0...10 V	2-position On/Off	2-position PWM	Modulating 3-position	Modulating KNX
RDG400KN RDG405KN	Y10	Y1 ¹⁾	Y1 ¹⁾	Y1/Y2 ¹⁾ (1 x ▲ / ▼)	KNX LTE-Mode

1) Either On/Off, PWM or 3-position (triac)

For configuration of the control outputs, refer to section 3.7.4.

3.7.2 Control output for air flow

DC 0...10 V control signal

The demand calculated by PI control from the current room temperature and the setpoint is delivered to the damper actuator as a modulating DC 0...10 V signal via output Y10.

3-position control signal

A 3-position control output for an air damper has 2 control signals, one for the **Open** command and one for the **Close** command. The thermostat features an internal stroke model to calculate the position of the actuator. Therefore, the running time from the fully closed to the fully open position must be adjusted via P44 (from 20 to 300 seconds; factory setting is 150 seconds).

Control signal (KNX LTE mode only)

A VAV compact controller receives its control signal via KNX bus. For communication settings (geographical zone, air distribution zone), refer to sections 3.10.3 and 3.10.13.

Synchronization

On single-duct applications, a closing synchronization is effected to readjust the internal stroke model to the real position of the actuator.

1. When the thermostat starts up, a closing signal (actuator running time + 150% = 2.5 x running time) is delivered to ensure the actuator will be fully closed and synchronized with the control algorithm.
2. Each time the thermostat calculates the fully closed position, the actuator's running time is extended + 150% to ensure the correct position of the actuator.
3. When the actuator reaches the position calculated by the thermostat, a waiting time of 30 seconds is observed to stabilize the outputs.

Note

"Opening" synchronization is available for valve outputs only.

3.7.3 Control output for electric heater, radiator and heating/cooling coil

On/Off control signal (valve, 2-position)

The valve receives an **Open/On** command via control output Y1 when ...

1. the acquired room temperature is below the setpoint (heating mode) or above the setpoint (cooling mode),
2. the control outputs have been inactive for more than the "Minimum output off-time" (factory setting 1 minute).

Off command for valve output when ...

1. the acquired room temperature is above the setpoint (heating mode) or below the setpoint (cooling mode),
2. the valve has been active for more than the "Minimum output on-time" (factory setting 1 minute).

Electric heater control signal (2-position)

The electric heater receives an **On** command via output Y1 when ...

1. the acquired room temperature is below the "Setpoint for electric heater",
2. the electric heater has been switched off for at least 1 minute.

The **Off** command for the electric heater is output when ...

1. the acquired room temperature is above the setpoint (electric heater),
2. the electric heater has been switched on for at least 1 minute.

Caution

A safety thermostat (to prevent overheating) must be provided externally.

DC 0...10 V for electric heaters

- The demand calculated by PI control from the current room temperature and the setpoint are delivered via Y10 as a modulating DC 0...10 V signal
- The signal converter (SEM61.4) converts the DC 0...10 V signal to AC 24 V PDM pulses for the current valve
- The current valve (SEA45.1) supplies the electric heater with AC 50...660 V pulsed current

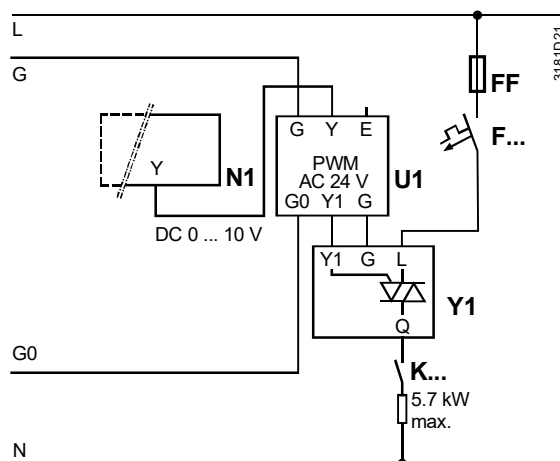

- N1 RDG400KN
 U1 Signal converter SEM61.4 (see Data Sheet N5102)
 Y1 Current valve SEA45.1 (see Data Sheet N4937)
 K... Safety loop (e.g. safety thermostat and high-temperature cutout)
 FF Very fast-acting fuse
 F... Overcurrent trip

3-position control signal	<p>Output Y1 delivers the Open command, and Y2 the Close command to the 3-position actuator.</p> <p>The factory setting for the actuator's running time is 150 seconds. It can be adjusted via P44 (Y1 and Y2).</p> <p>The parameter is only visible if 3-position is selected via DIP switch 5 or the commissioning tool.</p>
Synchronization	<ol style="list-style-type: none"> 1. When the thermostat is powered up, a Close command for the actuator's running time + 150% is delivered to ensure that the actuator fully closes and synchronizes to the control algorithm. 2. When the thermostat calculates the positions "Fully closed" or "Fully open", the actuator's running time is extended + 150% to ensure the correct actuator position is synchronized with the control algorithm. 3. After the actuator reaches the position calculated by the thermostat, a waiting time of 30 seconds is applied to stabilize the outputs.
PWM control	<p>The demand calculated by PI control from the current room temperature and the setpoint is delivered via Y1 to the valve actuator as a PWM signal (pulse width modulation) for thermal actuators. The output is switched on for a period proportional to the heating/cooling demand and then switched off for the rest of the PWM interval.</p> <p>The interval is 150 seconds (factory setting). It can be adjusted via P44 (Y1). The parameter is only visible if 2-position is selected via DIP switch 5 or the commissioning tool.</p>
Note	For PWM, the integral time (P35) must be set to 0!
PWM for thermal valve actuators	For thermal valve actuators, set the running time to 240 seconds.
Notes	<ul style="list-style-type: none"> • Never apply PWM to an electromotoric actuator • It is not possible to ensure exact parallel running of more than 2 thermal valve actuators. If several VAV systems are driven by the same thermostat, preference should be given to electromotoric actuators with On/Off or 3-position control
PWM for electric heaters	<p>For electric heaters, set the running time to 90 seconds.</p> <p>To avoid burn-off of mechanical contacts by frequent switching, use a current valve (e.g. SEA45.1) in place of a relay or contactor.</p>
Note!	For PWM, the integral time (P35) must be set to 0.

3.7.4 Control outputs configuration (setting via DIP switches 4 and 5 or tool, and P46...P47)

Application ↓	Control outputs	On/Off (2-position)	Modulating PWM (2-position)	Modulating 3-position	Modulating DC 0...10 V	Modulating KNX
Single-duct				✓	✓	✓
Single-duct and electric heater		✓	✓	✓	✓	✓
Single-duct and radiator/floor heating		✓	✓	✓	✓	✓
Single-duct heating/cooling coil		✓	✓	✓	✓	✓

The function of the control outputs is set via DIP switches 4 and 5:

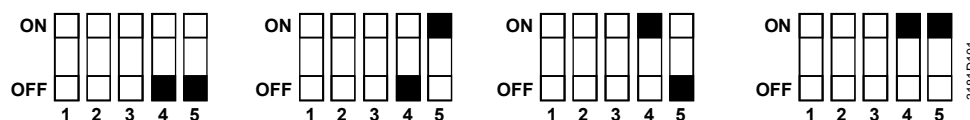

DIP 4: Y10 =	DC 0...10 V	DC 0...10 V	DC 10...0 V (inverted)	DC 10...0 V (inverted)
DIP 5: Y1/Y2 =	2-position	3-position	2-position	3-position

Notes

Y1-Y2:

- If 2-position is selected, the factory setting is On/Off.
If PWM is required (pulse width modulation), P46 must be set to 2 = PWM

P47:

- 0 = VAV box: DC 0...10 V control signal or KNX LTE-Mode
- 1 = VAV box: 3-position control signal

All DIP switches must be set to OFF if the application is commissioned via tool. In this case, the control outputs must be set via the ACS tool.

For details concerning connection of peripheral devices and setting of the DIP switches, refer to the Mounting Instructions M3192 [3].

Example Single-duct with 3-position damper actuator:

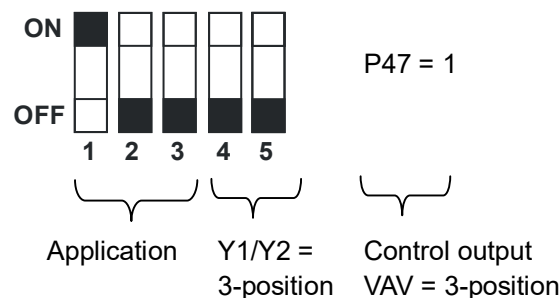

3.8 Multifunctional input, digital input

The thermostat has 2 multifunctional inputs X1 and a digital input D1. An NTC type sensor like the QAH11.1 (AI, analog input) or a switch (DI, digital input) can be connected to the input terminals. The functionality of the inputs can be configured via P38 and P39 for X1, and P42 and P43 for D1.



The current temperature or state of the inputs X1 and D1 is available on the bus for monitoring purposes.

The parameters can be set to the following values:

#	Function of input	Description	Type X1	Type DI
0	Not used	No function.	--	--
1	External/return air temperature	Input for external room temperature or return air temperature sensor to acquire the current room temperature, or floor heating temperature sensor to limit the heating output. Note: The room temperature is acquired by the built-in sensor if the "Floor temperature limitation" function is enabled via P51.	AI	--
2	Heating/cooling changeover	Sensor input for "Automatic heating/cooling changeover" function. A switch can also be connected rather than a sensor (switch closed = cooling, see section 3.4.1). With single-duct applications, the input changes over the air sequence; With single-duct with heating/cooling coil applications, the input changes over the water sequence (heating/cooling coil) Heating/cooling changeover is also possible via bus. ("Supply air temperature" for changeover air, "Heating/cooling changeover" for changeover water). In this case, the function must not be assigned to any local input X1-D1 (also refer to section 3.4.1). Diagnostic value 0 °C is displayed for closed contact/ 100 °C for open contact, if a switch is connected.	AI/DI	DI
3	Operating mode switchover (RDG400KN only)	Digital input to switch over the operating mode to Economy. If the operating mode switchover contact is active, user operations are ineffective and OFF is displayed. Operating mode switchover is also possible via bus. In this case, the function must not be assigned to any local input X1-D1 (also refer to section 3.2).	DI	DI
3	Window contact (RDG400KN only)	Digital input to switch over the operating mode to Protection. If the window contact is active, user operations are ineffective and OFF is displayed. Window contact is also possible via bus. In this case, do not assign the function to any local input X1-D1 (also refer to section 3.2).	DI	DI
4	Dewpoint monitor	Digital input for a dewpoint sensor to detect condensation. Cooling is stopped if condensation occurs.	DI	DI



Supply air temperature
Heating/
cooling
changeover



Window
state

#	Function of input	Description	Type X1	Type D1
5	Enable electric heater	Digital input to enable/disable the electric heater via remote control. Enable electric heater is also possible via bus. In this case, the function must not be assigned to any local input X1-D1 (also refer to section 3.6).	DI	DI
6	Fault	Digital input to signal an external fault (example: dirty air filter). If the input is active, ALx is displayed and a fault is sent on the bus (also refer to section 3.10.11). (Alarm x, with x = 1 for X1, x = 3 for D1). Note: Fault displays have no impact on the thermostat's operation. They merely represent a visual signal.	DI	DI
7	Monitoring input (Digital)	Digital input to monitor the state of an external switch via bus.	DI	DI
8	Monitoring input (temperature)	Sensor input to monitor the state of an external sensor (e.g. QAH11.1) via bus.	AI	--
9	Presence detector (RDG405KN only)	Presence detector input switches the operating mode to Comfort when the room is occupied and switches back to Economy when the room is unoccupied. Presence detector is also possible via bus. In this case, do not assign the function to any local input X1-D1 (also refer to section 3.2.1).	DI	DI



Enable electric heater



Fault information



D1, X1 (Digital)



X1, (Temp.)



Presence detector

- Operational action can be changed between normally open (NO) and normally closed (NC) via P39 (or P43 if a digital input)
- Each input X1 or D1 must be configured with a different function (1...5).
Exception: 1 or 2 or 3 inputs can be configured as fault (6) or monitoring input (7, 8)
- X1 is factory-set to "External sensor" (1) and D1 to "Operating mode switchover" (3)

For more detailed information, refer to section 0.

Installation

- For inputs X1-D1, one physical switch can be used for up to 20 room thermostats (parallel connection).
Caution! Do not mix X1 (mains potential) and D1
- For sensors on inputs X1-D1, the cable length is max. 80 m

Air damper position VAV via U1 (RDG400KN, RDG405KN)

The information about the thermostat's damper position can be used to influence the fan speed of a primary air handling unit. The thermostat receives the damper position from a damper actuator or a VAV compact controller as a DC 0...10 V signal using input U1. The damper position (0...100%) is sent on the bus.



U1 (0...100%)

An RMU7.. primary controller uses the LTE information of all connected room thermostats to calculate the total air flow demand.
The state of U1 can be monitored via communication object 36 "U1".

VAV air damper position (KNX LTE-Mode only) (RDG400KN, RDG405KN)

The present air damper position is transmitted on the KNX bus.
For communication settings (geographical zone, air distribution zone), see sections 3.10.2 and 3.10.3.

Input U1 (RDG405KN)

On the RDG405KN, the analog input U1 can be used for different purposes. This input can be set via P40.

#	Function of input	Description
0	Not used	No function.
1	Input for air damper position	See section above "Air damper position VAV via U1"
2	Input IAQ sensor	Input for an external analog CO ₂ /VOC sensor. This input is calibrated for a sensor range of 0...2000 ppm and cannot be set.



- The U1 value is always available on the bus via S-Mode object (e.g. object 36 on the RDG400KN and RDG405KN), even with selection P40 = 0
- The thermostat does not make a distinction between the DC 0...10 V signal from a CO₂ sensor and that from a VOC sensor

3.9 Handling faults

Temperature out of range

When the room temperature is outside the measuring range (that is above 49 °C or below 0 °C), the limiting temperatures blink, e.g. **0 °C** or **49 °C**.

In addition, the heating output is activated if the current setpoint is not set to OFF, the thermostat is in heating mode and the temperature is below 0 °C.

For all other cases, no output is activated.

The thermostat resumes Comfort mode when the room temperature returns to within the measuring range.



For fault status messages on the bus, refer to section 3.10.11.

3.10 KNX communications

The RDG..KNX room thermostats support communications as per KNX specification.

S-Mode Standard mode; engineering via group addresses

LTE-Mode Logical Tag Extended mode, for easy engineering, used in connection with Synco

3.10.1 S-Mode

This mode corresponds to KNX communications.

Connections are established via ETS by assigning communication objects to group addresses.

3.10.2 LTE-Mode

LTE-Mode was specifically designed to simplify engineering. Unlike with S-Mode, there is no need to create the individual connections (group addresses) in the tool. The devices autonomously establish connections.

Definitions

To make this possible, the following conditions are predefined:

- Every device or subdevice is located within a zone
- Every data point (input or output) is assigned to a zone
- Every data point (input or output) has a precisely defined "Name"

Whenever an output and an input with the same "Name" are located in the same zone, a connection is established automatically, as shown in the following diagram:

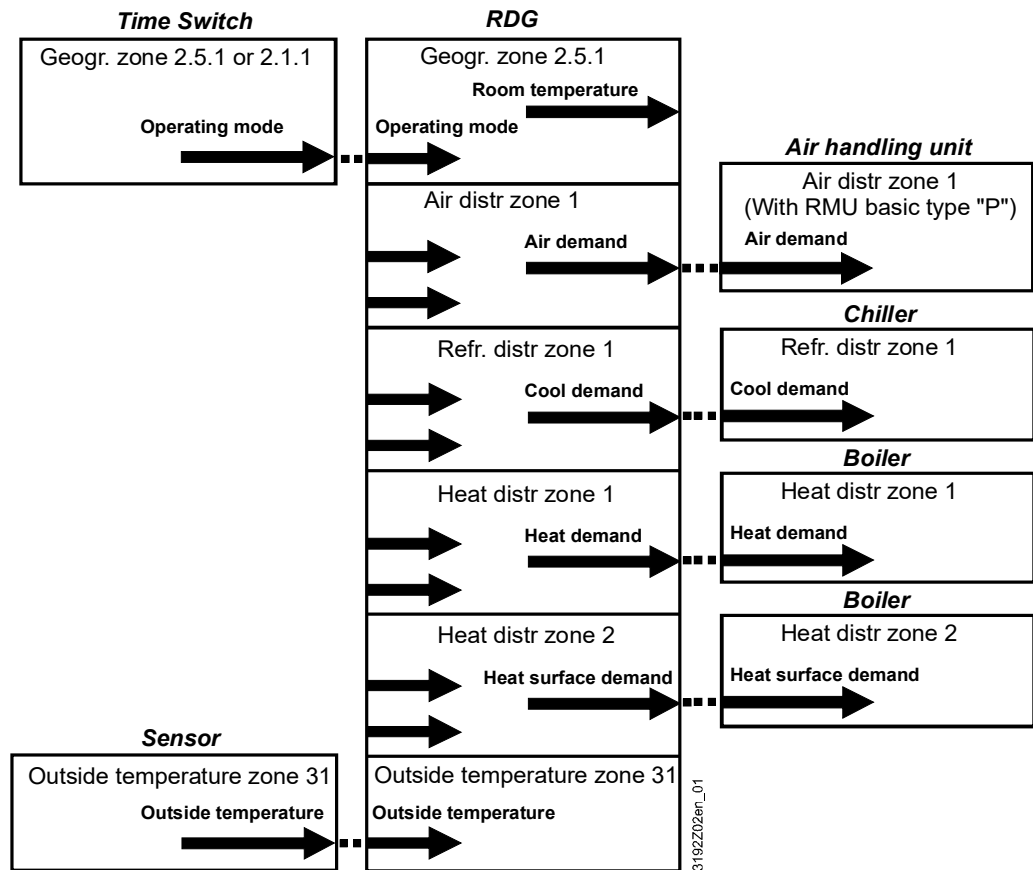

Engineering and commissioning

- For a detailed description of KNX (topology, bus supply, function and setting of LTE zones, filter tables, etc.), refer to Basic Documentation "Communication via the KNX bus for Synco 700, 900 and RXB/RXL" [6]
- LTE-Mode data points and settings are described in the Synco Application Manual [12]
- To engineer and commission a specific system, use the Synco700 planning and commissioning protocol (XLS table in HIT) [7]

3.10.3 Zone addressing in LTE-Mode (in connection with Synco)

In cases where RDG..KNX room thermostats are used in LTE-Mode (e.g. in connection with Synco), zone addresses need to be allocated. The following zone addresses must be defined together with the Synco devices at the planning stage depending on the application:

Short description	Factory setting	Parameter
Geographical zone (apartment)	--- (out of service)	P82
Geographical zone (room)	1	P83
Heat distribution zone heating coil	--- (out of service)	P84
Refr distribution zone cooling coil	--- (out of service)	P85
Heat distribution zone heating surface	--- (out of service)	P86
Air distribution zone	--- (out of service)	P87

Note

"Subzone" of "Geographical zone" is fix 1 (not adjustable). The device sends and receives LTE communication signals only if the zone address is valid (not OSV = out of service).

The zones to be defined are as follows:

<p>Geographical zone (space zone) (Apartment . Room . Subzone) Apartment = ---, 1...126 Room = ---, 1...63 Subzone = fix 1</p>	<p>Zone in which an RDG..KNX thermostat is physically located. Other room-specific devices may also be located in this zone.</p> <p>Information exchanged in this zone is related specifically to the device like operating mode, setpoints, room temperature, etc.</p> <p>The designations "Apartment", "Room" and "Subzone" do not need to be taken literally. For example, "Apartment" can be used to refer to a group of rooms, floor or section of a building. "Room", however, really does refer to a room.</p> <p>Subzone is not used for HVAC devices. It is more relevant to other disciplines, such as lighting. Subzone is fix at "1" and not visible.</p> <p>The time switch information is expected from the same zone where the thermostat is located (Residential).</p> <p>If no time switch information is received from the same zone, the thermostat uses the information received from the same apartment but with room "1" A.1.1 (Office).</p> <p>Example: Commercial building</p> <p>In a commercial building, the time switch information is sent by the RMB795 central control unit. The zones are divided into so-called "Room groups" (e.g. 1...4), where each "Room group" can have an individual schedule. A room thermostat in the same "Room group" need to have the same Apartment Address.</p> <p>Legend: D = device address (P81) G = geographical zone (P82, P83) (Apartment.Room.Subzone)</p>
---	---

3171201

<p>Heat distribution zone</p>	<p>Information related specifically to the hot water system in heating coils</p>
--------------------------------------	--

heating coil Zone = ---, 1...31	is exchanged within this zone. The zone also includes a Synco device to process the information (e.g. RMH7.. or RMU7.. with changeover).
Heat distribution zone heating surface (radiator) Zone = ---, 1...31	Information related specifically to the hot water system of a radiator is exchanged within this zone (e.g. heating demand). This zone also includes a Synco device to process the information (e.g. RMH7.. or RMB7..).
Refrigeration distribution zone cooling coil Zone = ---, 1...31	Information related specifically to the chilled water system is exchanged within this zone (e.g. cooling demand). This zone also includes a Synco device to process the information (e.g. RMU7..).
Air distribution zone Zone = ---, 1...31	This distribution zone is for air applications (VAV, CAV). Information related specifically to the air handling system is exchanged within this zone (e.g. air demand). This zone also includes a Synco device to process the information (RMU7.. basic type P).
Outside temp. zone Zone = fix 31	Outside temperature received in outside temperature zone 31 will be/ can be displayed on the thermostat if commissioned accordingly (P07 = 2).

3.10.4 Example of heating and cooling demand zone

The building is equipped with Synco controls on the generation side and RDU../RDG.. room thermostats on the room side.

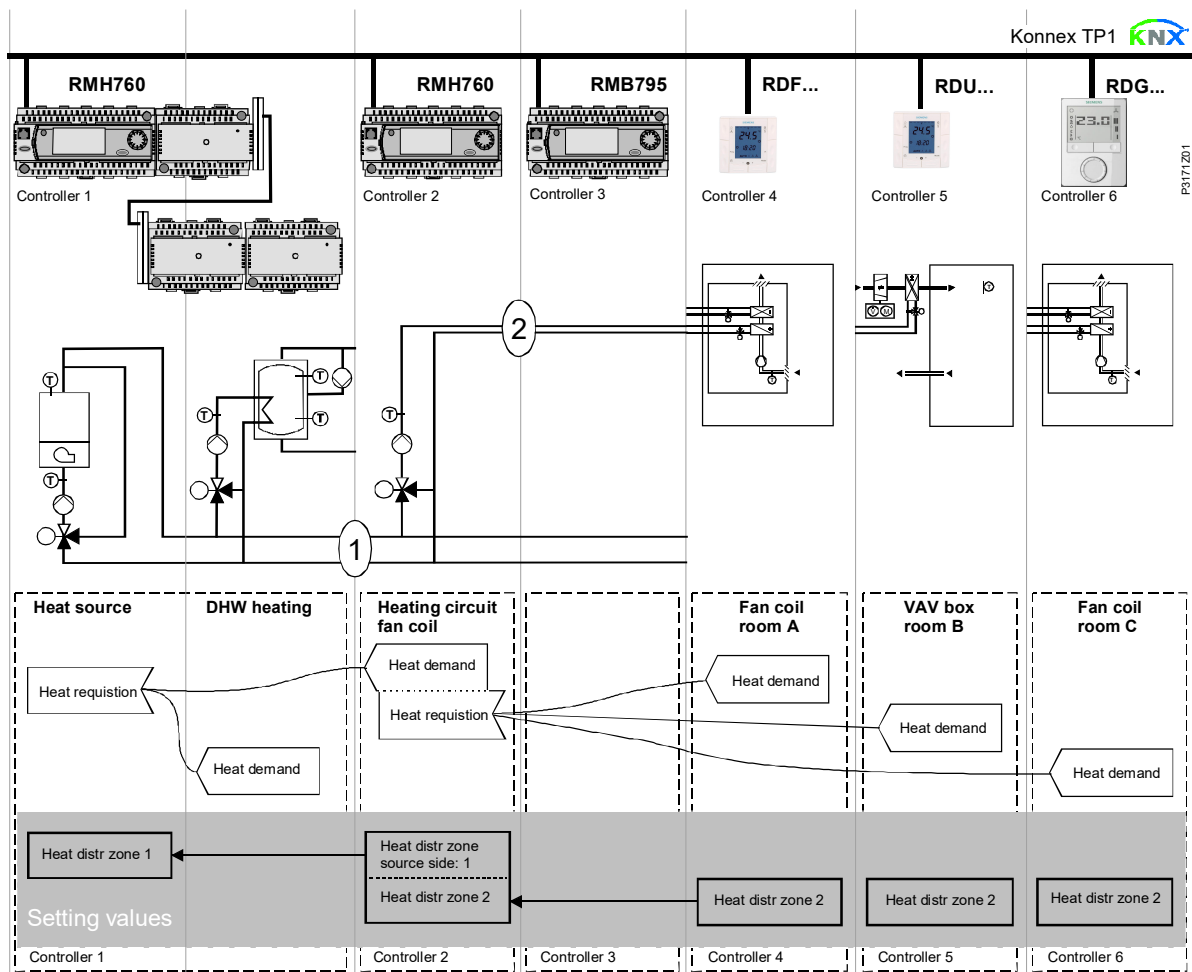

Explanation relating to the illustration

In the case of a typical application, the individual RDU../RDG.. room thermostats – when used with the RMB795 central control unit – signal their heat demand directly to the primary controller (in the above example to the RMH760).

(1) and (2) designate the numbers of the distribution zone.

Note

This type of application can analogously be applied to refrigeration distribution zones.

3.10.5 Send heartbeat and receive timeout

In a KNX network, S-Mode and LTE-Mode communication objects can be exchanged between individual devices. The **Receive timeout** defines the period of time within which all the communication objects requested from a device is received at least once. If a communication object is not received within this period of time, a predefined value is used.

Similarly, the **Send heartbeat** defines the period of time within which all the communication objects requested must be transmitted at least once.

LTE-Mode/S-Mode

Fixed times are specified as follows:

- Receive timeout: 31 minutes
- Send heartbeat: 15 minutes

Object [KNX obj. Nr.]	I/O	Minutes	Default value
Room operating mode: Time switch [12]	Receive	31	Comfort
Room operating mode: Preselection [7]	Receive	31	Auto
Application mode [31]	Receive	31	Auto

Reducing the bus load

Individual zones can also be disabled (out of service) via control parameter if not used. In disabled zones, the LTE signal is no longer periodically sent, and will therefore reduce the bus load.

3.10.6 Startup

Startup response

The application is restarted after every reset, so that all the connected motorized valve actuators are synchronized (see "Control outputs", 0).

Startup delay

After a reset, it takes up to 5 minutes for all the connected room thermostats to restart, thus avoiding network overloads when restarting. At the same time, it reduces the load on the KNX network, since not all thermostats transmit data at the same time. The delay ($T_{WaitDevice}$) is determined by the thermostat's device address. After the delay, the device starts to send.

3.10.7 Heating and cooling demand

In connection with Synco, the heating and/or cooling demand (for water) from each room is transmitted to the BACS to provide the required heating or cooling energy.

An example for LTE-Mode is described in section 3.10.4.

In S-Mode, the current state signals of the control outputs are available.



Heating output primary
Cooling output primary

3.10.8 Air demand

In connection with Synco, the air demand from each room is transmitted to the BACS to provide the required air volume.

In S-Mode, the current state signal of the air damper is available.



Control output VAV

3.10.9 Electric heater interlock by supply air controller (LTE-Mode only)

To avoid overheating of an electric heater, sufficient flow of supply air must be guaranteed. The thermostat features the function "Interlock of electric heater via supply air controller", which is active when a supply air controller (e.g. Synco RMU7..) is used in the system. The controller of the supply air fan sends the fan status (StatusSATC) to the thermostat when the fan is running, after which the electric heater is allowed to turn on if there is a call for heat.

When the supply air fan is not running, the electric heater is kept turned off, even though there is a demand for heat.

The fan symbol  is displayed when the supply air fan is running.

Notes

- Electric heater enable via local input X1-D1 or KNX overrides any release by this interlock function, and vice versa (last intervention wins)
- After power-up of the thermostat, the electric heater is completely disabled for at least 5 minutes or until a supply air controller is detected. If no supply air fan controller is used, the electric heater is allowed to turn on if there is a demand for heat
- The fan information is broadcast every 15 minutes or on change of value. If no value is received any more, the thermostat deactivates the interlock function after a timeout of 31 minutes

Caution

General rule: In case of insufficient air flow, the thermostat cannot protect the electric heater against overtemperature. For this reason, the heater **must** be equipped with a separate safety device (thermal cutout).

3.10.10 Primary fan overrun after switching off the electric heater

To avoid overheating of the electric heater after it has been switched off, the air flow must be maintained for a while.

In connection with a supply air controller (e.g. Synco RMU7..) this will be automatically ensured by exchanging the necessary information. The controller of the supply air fan will only switch off the supply air fan when all electric heaters are cooled off.

Note

The cool off time of the electric heater can be adjusted for each heater via P54 (factory setting is 60 seconds).

Caution 

General rule: In case of insufficient air flow, the thermostat cannot protect the electric heater against overtemperature. For this reason, the heater **must** be equipped with a separate safety device (thermal cutout).

3.10.11 Fault function on KNX

If a fault occurs (e.g. digital fault input, dewpoint, communication configuration, etc.), a fault is sent on the bus.







An RDG.. thermostat listens on the bus and sends its fault when it has the highest alarm priority. This ensures that the management station does not miss any alarms. If alarms occur at the same time, the alarm with the highest priority is first displayed and sent on the bus.



Fault transmission is different in LTE- and S-Mode:

S-Mode	LTE-Mode
Fault state	Alarm info (error code and internal information)
Fault information (internal information)	Alarm text (default text can be edited with ACS tool)

The table below shows the error code and default alarm texts:

Prio	Fault	Thermostat	Fault information on the bus		
		Display	Error code	Default fault text	Text adjustable *)
-	No fault	---	0	No fault	✓
1	Bus power supply**)	 bus	5000	No bus power supply	---
2	Device address error	 Addr	6001	>1 id device address	---
3	Condensation	 	4930	Condensation in the room	✓
4	External fault input X1	 AL1	9001	Fault input 1	✓
5	External fault input D1	 AL3	9003	Fault input 3	✓

*) Default alarm texts are stored in the thermostat's non-volatile memory and can be adjusted using the ACS tool

**) This error will not be sent on the bus (because there is no bus!)

Priority of alarms



Fault transmission

- Priority order is #1...5
- External faults #4...5: If faults are active, the display shows **AL1, AL3** alternating. On the bus, only the fault with the highest priority is sent

A supervisor alarm system may command the thermostat to stop sending faults to the bus via the communication object "Fault transmission" (disable/enable).

This has no impact on the local display of faults.

After a timeout of 48 hours, sending of faults will automatically be enabled again.

3.10.12 Emergency control (LTE-Mode only)

In case of smoke or fire, the air damper can be overridden via KNX.

The necessary information is provided by function block "HVAC Emergency Mode".

The table below describes the behavior of the controller output:

#	Data point value	Air damper
0	Normal	Normal operation
1	EmergPressure	Fully open
2	EmergDepressure	Fully closed
3	EmergPurge	Fully open
4	EmergShutdown	Fully closed
5	EmergFire	Fully closed

Emergency signals have the highest priority and command the control output accordingly. Any ongoing function like fan-overrun, etc., is stopped immediately.

The priority is as follows:

1. Smoke (Emergency 1...4)
2. Fire (Emergency 5)
3. Fan overrun (Emergency 0 and electric heater fan overrun function is active)
4. Normal operation (Emergency 0 and operation by operating mode button)

3.10.13 Application with VAV compact controller (KNX LTE-Mode only)

For applications with RDG.. and VAV compact controller (KNX LTE-Mode), the information (control signal, current air damper position) is transmitted on the KNX bus. The communication between the devices is established by setting the KNX parameters in the thermostat and in the VAV compact controller.

Example	KNX parameter	RDG..	GDB..KN	GDB..KN
	KNX address	0.1.2	0.1.3	0.1.4
	Master/slave		Master	Slave
	Type of damper actuator		Supply air	Extract air
	Geographical zone (apartment)	1	1	1
	Geographical zone (room)	1	1	1
	Air distribution zone	5	5	5

For information on applications with supply air and extract air, refer to section 3.4.1. For details on KNX parameters in LTE-Mode, refer to section 3.10.3.

3.11 Communication objects (S-Mode)

3.11.1 Overview



Page	Object # and name	Thermostat	Object # and name	Page
13	1 System time	→		
13	3 Time of day	→		
13	38 Outside temperature	→	↔ 21 Room temperature *)	13
18	12 Room operating mode: Time switch ¹⁾	→	→ 16 Room operating mode: State ¹⁾	16
18	7 Room operating mode: Preselection ¹⁾	↔	→ 24 Room temperature: Current setpoint	27
17, 19, 51	20 Room operating mode: Window state	→	→ 25 Control output VAV	58
27	22 Room temperature: Comfort basic setpoint	→	→ 26 Heating output primary ²⁾	58
27	23 Room temperature: Comfort setpoint	↔	→ 27 Cooling output primary ²⁾	58
35	31 Application mode	→	→ 37 D1	52
52	28 Enable electric heater	→	→ 32-33 X1 (temperature/digital)	52
31, 51	30 Supply air temperature	→	→ 36 U1 (0...100%)	52
51	29 Heating/cooling ch'over ²⁾	→		
60	6 Fault transmission	→	→ 5 Fault state	33, 59
20	39 Presence detector ³⁾	→		
27	40 Economy heating setpoint ³⁾	→		
27	41 Economy cooling setpoint ³⁾	→		
66	42 Supply air: limit value min ³⁾	→		
66	43 Supply air: limit value max ³⁾	→		
66	44 CO ₂ concentration ³⁾	↔	→ 4 Fault information	33, 52, 59

- Input communication object
- Output communication object
- ↔ Input and output communication object

1) 8-bit and 1-bit object available, selectable via parameter in ETS
 2) Availability depending on selected application/function
 3) Only on RDG405KN
 *) **Transmit** only on RDG400KN
Transmit and Receive on RDG405KN

3.11.2 Description of communication objects

Obj	Object name	Function	Type/length	Flags
1	System time	Time and date	19.001 8 Byte	CWU
System time for display on the thermostat (see P07 (3 or 4))				
3	Time of day	Time and date	10.001 3 Byte	CWU
Another object for receiving the time of day for display on the thermostat (see P07 (3 or 4))				
4	Fault information	Alarm Info	219.001 6 Byte	CT
Common alarm output. If an alarm occurs, the alarm number is transmitted				
5	Fault state	Faulty/ normal	1.005 1 bit	CT
Common alarm output. If an alarm occurs, the alarm flag is set				
6	Fault transmission	Enable/ disable	1.003	CWU
A supervisor alarm system can disable the broadcasting of alarms by the devices. This has no impact on the local display of alarms. After a timeout of 48 hours, the sending of faults will automatically be enabled again.				
7	Room operating mode: Preselection	Auto Comfort PreComf. Economy Protection	20.102 1 Byte	CWTU
Controls the room operating mode selection of the thermostat via bus. The command can also be submitted as four 1-bit communication objects (8...11). The last interaction wins – either from local operating mode button or via bus. Note: The thermostat changes Precomfort either into Economy or Comfort (selectable via P88).				
8	Operating mode: Preselection	Trigger	1.017 1 bit	CW
9	Auto			
10	Comf			
11	Eco			
11	Prot			
Switch room operating mode to either Auto, Comfort, Economy or Protection. The last interaction wins – either from the local operating mode button or via bus.				
12	Room operating mode: Time switch	Comfort Economy PreComf. Protection	20.102 1 Byte	CWU
This information is provided by a central time switch or a supervisor and defines the actual HVAC operating mode. The command can also be submitted via three 1-bit communication objects (13...15). Protection mode has the highest priority and cannot be overridden. Note: The thermostat changes Precomfort either into Economy or Comfort (selectable via P88).				
13	Time switch	Trigger	1.017 1 bit	CW
14	Comfort			
15	Economy			
15	Protection			
Switch the HVAC mode to either Comfort, Economy or Protection.				

Obj	Object name	Function	Type/length	Flags
Effective room operating mode used by the thermostat (considering time switch, user selection, window contact, etc.) This state information is available via one 8-bit enumeration or three 1-bit communication objects (17...19). Note: The thermostat does not support Precomfort mode.				
17	Room operating mode:	ON OFF	1.002 1 bit	CT
18	State Comfort			
19	State Economy			
19	State Protection			
Corresponding communication object sends "True"				
20	Window state	Open Closed	1.019 1 bit	CWU
The thermostat is set to Economy mode if value "1" (open) is received. It switches back to the previous mode when the value is "0" (closed). "Window state" is sent e.g. by a KNX switch or a KNX presence detector. It has the same effect as the local operating mode switchover contact X1, D1 (P38, P42). <i>Only one input source must be used, either local input X1-D1 or the KNX bus.</i>				
21	Room temperature (RDG400KN)	Temp. value	9.001 2 Bytes	CRT
The value of the room temperature acquired via built-in or external sensor is available via this communication object.				
22	Room temperature: Comfort basic setpoint	Temp. value	9.001 2 Bytes	CWU
If function "Temporary setpoint" is enabled via P69, then – after an operating mode change – the setpoint adjustments made by the user and via communication object 23 is dismissed and the thermostat will be reset to the Comfort basic setpoint. Note: Setpoints that have been changed via the local HMI may be overwritten during a system startup from a central master controller, e.g. RMB795. <i>The Comfort basic setpoint is stored in EEPROM (see section 3.3.2). → The service life of the EEPROM depends on the number of write cycles. Never write this communication object cyclically!</i>				
23	Room temperature: Comfort setpoint	Temp. value	9.001 2 Bytes	CWTU
Communication object used to shift the setpoint used by the thermostat (see section 3.3.2). Same priority as local setpoint shift on the thermostat. The last intervention wins. Note: The Comfort basic setpoint (object 22) will not be changed.				
24	Room temperature: Current setpoint	Temp. value	9.001 2 Bytes	CRT
Current setpoint, including shift, compensation, etc., used by the thermostat for temperature control				
25	Control output VAV	0...100%	5.001 1 Byte	CRT
Indicates the position of the air damper. E.g. single-duct				
26	Heating output primary	0...100%	5.001 1 Byte	CRT
Indicates the position of the heating actuator of the electric heating. E.g. single-duct with electric heater application: Output of the electric heater.				
27	Cooling output primary	0...100%	5.001 1 Byte	CRT

16	Room operating mode: State	Comfort Economy Protection	20.102 1 Byte	CRT
----	-----------------------------------	----------------------------------	------------------	-----

Obj	Object name	Function	Type/length	Flags
Indicates the position of the cooling actuator of the first stage. E.g. single-duct with h/c coil application: Output of the cooling coil				
28	Enable electric heater	Enable/disable	1.003 1 bit	CWU
An electric heater can be disabled with this communication object (e.g. to meet tariff regulations). The same function is also available via local multifunctional input X1-D1 (P38, P42). <i>Only one input source must be used, either local input X1/D1 or KNX bus.</i>				
29	Heating/cooling changeover	Heating/cooling	1.100 1 bit	CWU
Changeover information transmitted via bus. Only available with application "Single-duct with heating/cooling coil". Default: Current mode before power down. The same function is also available via local multifunctional input X1-D1 (P38, P42). <i>Only one input source must be used, either local input X1/D1 or KNX bus.</i>				
30	Supply air temperature	Temp. value	9.001 2 Byte	CWU
The supply air temperature sent by the supply air controller indicates whether cold or hot air is supplied (for VAV changeover). The controller determines the necessity to open or close the air damper according to the supply air temperature, the room temperature setpoint, and the current room temperature. The same function is also available via local multifunctional input X1-D1 (P38, P42). <i>Only one input source must be used, either local input X-D1 or KNX bus.</i>				
31	Application mode	HVAC control mode	20.105 1 Byte	CWU
0	Auto (default)	Heating and/or cooling		
1	Heat	Heating only		
2	Morning warmup*	Heating only		
3	Cool	Cooling only		
4	Night purge	Open air damper fully		
5	Precool*	Cooling only		
6	OFF	Neither heating nor cooling		
8	Emergency heat*	Heating only		
9	Fan only	Open air damper fully (= night purge)		
* Function handled like Heat (1) or Cool (3)				
32	X1: Temperature	Temp. value	9.001 2 Byte	CRT
Indicates the values of the temperature sensors connected to the local inputs X1				
33	X1: Digital	ON	1.001	CRT
37	D1: Digital	OFF	1 bit	
Indicate the status of the digital inputs (adjusted via P39...P43) including considering the operating action				
36	U1: 0..10V	0...100%	5.001 8 bit	CRT

DC 0...10 V at input U1 is indicated as a value 0...100%				
38	Outside temperature	Temp. value	9.001 2 Byte	CWU
The outside temperature acquired by a KNX sensor can be displayed on the thermostat, if P07 "Additional user information" is set = 2 (outside temperature).				

The following objects are only available on RDG405KN

21	Room temperature (RDG405KN)	Temp. value	9.001 2 Bytes	CRT
The value of the room temperature measured via built-in or external sensor is available on bus when this communication object is set to Transmit . By setting the object to Receive , the thermostat receives and works with the room temperature from an external sensor				
39	Presence Sensor		1.018 1 bit	CWU
Room operating mode : Presence detector Switch the device to Comfort mode				
40	Room temperature: economy heating setpoint	Temp. value	9.001 2 bytes	CWU
Communication object to adjust the Economy heating setpoint used by the thermostat (see section 3.3.2). It directly changes the value of the local parameter "Economy setpoint" P11. S-Mode object needs to be enabled by setting Room temp.: Economy setpoints to as group object in ETS. The Economy setpoint is stored in EEPROM. The service life of the EEPROM depends on the number of write cycles. Never write this communication object cyclically.				
41	Room temperature: Economy cooling setpoint	Temp. value	9.001 2 bytes	CWU
Communication object to adjust the Economy cooling setpoint used by the thermostat (see section 3.3.2). It directly changes the value of the local parameter "Economy setpoint" P12. S-Mode object needs to be enabled by setting Room temp.: Economy setpoints to as group object in ETS. The Economy setpoint is stored in EEPROM. The service life of the EEPROM depends on the number of write cycles. Never write this communication object cyclically.				
42	Supply air : limit value min (%)	0...100%	5.001 1 Byte	CWU
The output signal for the air flow can be limited to a minimum value (P63)				
43	Supply air: Limit value max. (%)	0...100%	5.001 1 Byte	CWU
The output signal for the air flow can be limited to a maximal value (P64)				
44	IAQ: CO₂ concentration	ppm value	2 bytes	CWT
CO ₂ concentration in ppm. Range :0...5000 ppm				

3.12 Communication objects (LTE-Mode)

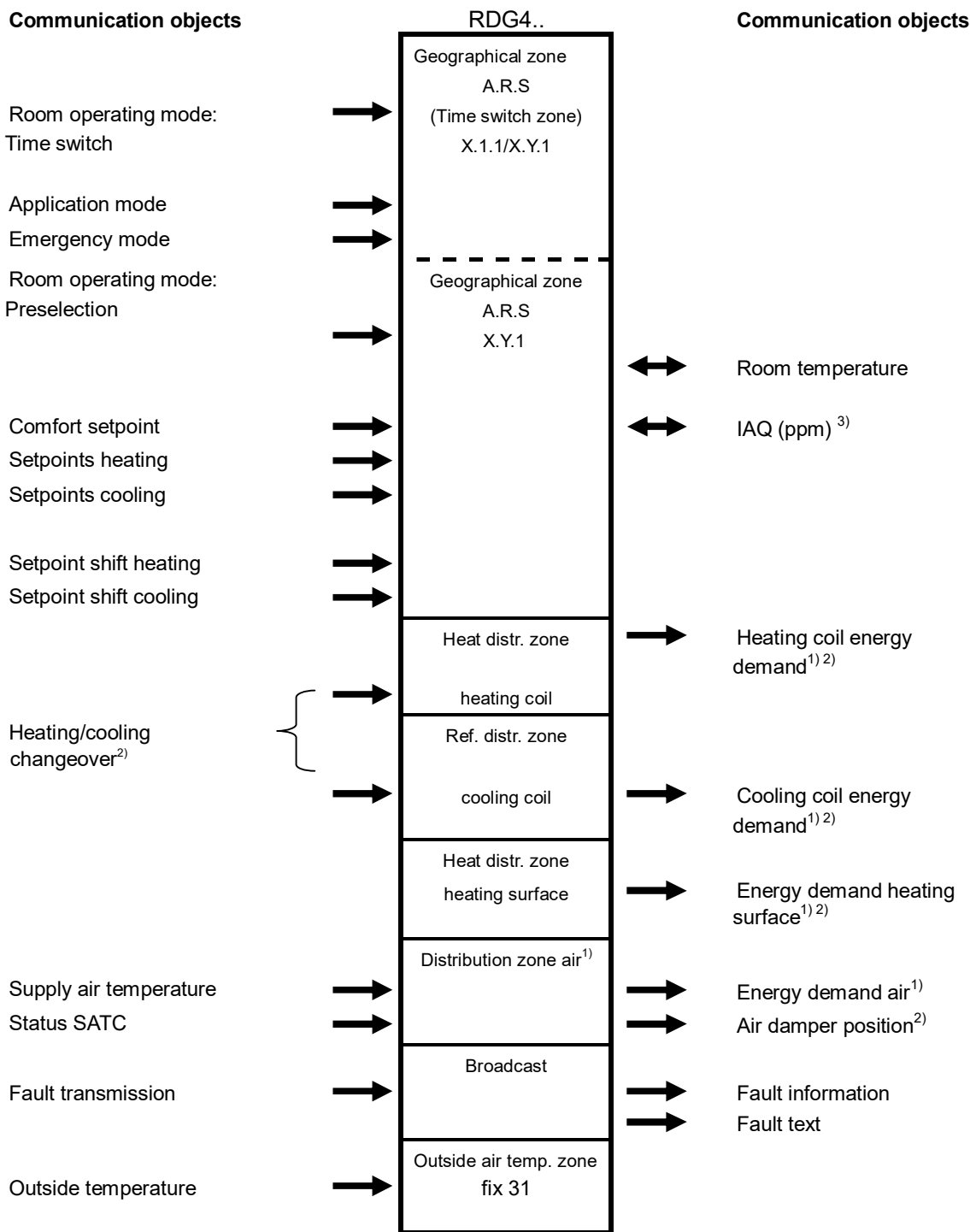

Note:

- 1) Available depending on selected application
- 2) Available only on RDG..
- 3) Only for RDG405KN

3.13 Control parameters

A number of control parameters can be readjusted to optimize the control performance. This can be done on the thermostat via HMI or via commissioning/operating tool. These parameters can also be set during operation without opening the unit.

In the event of a power failure, all control parameter settings are retained.

The control parameters are assigned to 2 levels:

- Service level, and
- Expert level including communications, diagnostics and test

The Service level contains a small set of parameters to set up the thermostat for the HVAC system and to adjust the user interface. These parameters can be adjusted any time.

Change parameters at the Expert level carefully, as they impact the thermostat's control performance and functionality.

3.13.1 Parameter setting via local HMI

- | | |
|---|---|
| Enter only Service level | <ol style="list-style-type: none">1. Hold down both the left and right buttons simultaneously for 4 seconds. Release them, and hold the right button again within 2 seconds until P01 displays.
Continue with step 2. |
| Enter Expert level with diagnostics and test | <ol style="list-style-type: none">1. Hold down both the left and right buttons simultaneously for 4 seconds. Release them, and hold the left button again within 2 seconds until the temperature disappears.
Turn the rotary knob counterclockwise minimum ½ rotation. Pxx displays.
Continue with step 2. |
| Adjusting parameters | <ol style="list-style-type: none">2. Select the required parameter by turning the rotary knob.3. Press button ✓ (OK); the current value of the selected parameter starts blinking and can be changed by turning the rotary knob.4. Press button ✓ (OK) to confirm the adjusted value or press button ↵ (Esc) to cancel the change.5. If you wish to adjust additional parameters, repeat steps 2...4.6. Press button ↵ (Esc) to leave the parameter setting mode. |
| Resetting parameters | <p>The factory setting for the control parameters can be reloaded via P71 by changing the value to "On". Confirm by pressing the right button. Then, 8888 displays during reloading.</p> |

3.13.2 Parameter setting/download via tool

The control parameters can be adjusted via bus either by parameter download during commissioning or during normal operation with a tool like the ACS.



ACS

With the ACS tool, the parameters can be changed ...

- during commissioning via parameter download (all parameters),
- during operations via Popcard (most of the parameters).

**OZW772 web server,
RMZ792-B bus operator
unit**

Most parameters can be changed during normal operation using the OZW772 web server or the RMZ792-B bus operator unit.



ETS

ETS is an engineering tool and can be used for the full commissioning of RDG...KNX room thermostats. Device address, application, and control parameters can be defined and downloaded via ETS.

Notes

- Setting RDG.. KNX parameters is only supported by ETS4 or higher/ACS version 5.11 (for RDG4..0KN), version 8.32 or higher (for RDG405KN) and version V10.02.080 or higher (for RDG400KN with SW version \geq V1.14)
- The RDG.. KNX room thermostats (without ETS parameter download) require version ETS4 or higher/ACS version 5.11 (for RDG4..0KN), version 8.32 or higher (for RDG405KN) and version V10.02.080 or higher (for RDG400KN with SW version \geq V1.14)

Connecting a KNX tool

Connecting a KNX commissioning/operating tool to the RDG.. is described in section 4.2.

3.13.3 Parameters of the Service level

Parameter	Name	Factory setting	Range	RDG400KN	RDG405KN	Dependencies
Service level						
P01	Control sequence	1 = Cooling only	0 = Heating only 1 = Cooling only 2 = H/C changeover manual 3 = H/C changeover auto	✓	✓	
P02	Operation via room op selector	1	1 = Auto - Protection 2 = Auto - Comfort - Economy - Protection	✓	✓	
P04	Unit	C (0)	C = degrees Celsius F = degrees Fahrenheit	✓	✓	
P05	Measured value correction	0 K	- 3...3 K	✓	✓	
P06	Standard display	0	0 = Room temperature 1 = Setpoint	✓	✓	
P07	Additional display information RDG400KN (range 0...4) RDG405KN (range 0...4, 6,7)	0	0 = --- (no display) 1 = °C and °F 2 = Outside temperature (via bus) 3 = Time of day (12 h) (via bus) 4 = Time of day (24 h) (via bus) 6 = CO ₂ concentration [ppm] 7 = CO ₂ symbols	✓	✓	
P08	Comfort basic setpoint	21 °C	5...40 °C	✓	✓	
P09	Comfort setpoint minimum	5 °C	5...40 °C	✓	✓	
P10	Comfort setpoint maximum	35 °C	5...40 °C	✓	✓	
P11	Economy heating setpoint	15 °C	OFF, 5...WCoolEco; WCoolEco = 40 °C max.	✓	✓	
P12	Economy cooling setpoint	30 °C	OFF, WHeatEco...40 °C; WHeatEco = 5C min.	✓	✓	
P14	Button lock	0	0 = Unlocked 1 = Auto lock 2 = Manual lock	✓	✓	
P19	CO ₂ (VOC) Setpoint	1000	OFF(0)...5000 ppm	X	✓	
P20	CO ₂ (VOC) P-band Xp	400	10...2000 ppm	X	✓	

Note Parameter display depends on selected application and function.

3.13.4 Parameters of the Expert level with diagnostics and test

Parameter	Name	Factory setting	Range	RDG400KN	RDG405KN	Dependencies
Expert level						
P30	Heat P-band Xp/switching diff	2 K	0.5...6 K	✓	✓	
P31	Cool P-band Xp/switching diff	1 K	0.5...6 K	✓	✓	
P32	Radiator P-band Xp/swi diff	2 K	0.5...6 K	✓	✓	Appl
P33	Dead zone Comfort mode	2 K	0.5...5 K	✓	✓	Appl
P35	Integral action time Tn RDG400KN RDG405KN	5 min 45 min	0...10 min 0...120 min	✓	✓	P46, P47
P36	H/C ch'over swi point cooling	16 °C	10...25 °C	✓	✓	P38
P37	H/C ch'over swi point heating	28 °C	27...40 °C	✓	✓	P38
P38	Input X1 RDG400KN (range 0..3 [ECO]..8) RDG405KN (range 0..3 [PROT]..10)	1: = Ext. sensor	0 = --- (no function) 1 = Room temp ext. sensor/ return air temp (AI) 2 = H/C changeover (AI/DI) 3 = Operat. mode contact [ECO], window contact [PROT] (DI) 4 = Dewpoint sensor (DI) 5 = Enable electric heater (DI) 6 = Fault input (DI) 7 = Monitoring input (Digital) 8 = Monitoring input (Temp) 10 = Presence detector (DI)	✓	✓	
P39	Normal position input X1	0 (NO)	0 = Normally open/open 1 = Normally closed/close	✓	✓	P38
P40	Input U1	0	0 = No function 1 = Input for air damper position 2 = input CO ₂ sensor	X	✓	
P42	Input D1 RDG400KN (range 0..3 [ECO]..7) RDG405KN (range 0..3 [PROT]..10)	3 = Operating mode contact (RDG400KN) Window contact (RDG405KN)	0 = --- (no function) 2 = H/C changeover (DI) 3 = Operat. mode contact [ECO], window contact [PROT] (DI) 4 = Dewpoint sensor (DI) 5 = Enable electric heater (DI) 6 = Fault input (DI) 7 = Monitoring input (Digital) 10 = Presence detector (DI)	✓	✓	
P43	Normal position input D1	0 (N.O.)	0 = Normally open/open 1 = Normally closed/close	✓	✓	P42
P44	Actuator running time Y1/Y2	150 s	20...300 s	✓	✓	P46
P46	Output Y1/Y2	On/Off (1)	0 = 3-position 1 = 2-position - ON/OFF 2 = 2-position - PWM	✓	✓	Appl
P47	Controller output VAV	0 = DC 0...10 V	0 = DC 0...10 V 1 = 3-position	✓	✓	Appl
P51	Flow temp limit floor heating	Off	Off, 10...50 °C	✓	✓	P38
P54	Fan overrun time	60 s	0...360 s	✓	✓	
P63	Supply air limit value min	0%	0...P64 (%)	✓	✓	
P64	Supply air limit value max	100%	P63...100 (%)	✓	✓	
P65	Protection heating setpoint	8 °C	OFF, 5...W CoolProt; W CoolProt = 40 °C max.	✓	✓	
P66	Protection cooling setpoint	Off	OFF, W HeatProt... 40; W HeatProt = 5 °C min.	✓	✓	
P68	Temporary Comfort mode	0 (= Off)	0...360 min	✓	✓	P02
P69	Temporary Comfort setpoint	Off	OFF = Disabled ON = Enabled	✓	✓	





Parameter	Name	Factory setting	Range	RDG400KN	RDG405KN	Dependencies
Expert level						
P71	Restore factory setting	OFF	OFF = Disabled ON = Reload start 8888 is displayed for 3 seconds during reload process	✓	✓	

Parameter	Name	Factory setting	Range	RDG400KN	RDG405KN	Dependencies
Communications						
P81	Device address 1)	255	1...255	✓	✓	
P82	Geographical zone (apartment) 2)	---	---, 1...126	✓	✓	
P83	Geographical zone (room) 2)	1	---, 1...63	✓	✓	
P84	Heat distr zone heating coil	---	---, 1...31	✓	✓	Appl, P01
P85	Refrig distr zone cooling coil	---	---, 1...31	✓	✓	Appl, P01
P86	Heat distr zone heating surface	---	---, 1...31	✓	✓	Appl
P87	Air distribution zone	---	---, 1...31	✓	✓	
P88	Transformation Precomfort	0	0 = Economy 1 = Comfort	✓	✓	

Notes

P46, P47: Setting to 2-position or 3-position is made with DIP switches 4 and 5

- Physical address = Area.Line.DeviceAddress. Factory setting for Area = 0, Line = 2.
Can be changed by special management service e.g. from line coupler or via ACS tool
- Type = geographical zone A.R.S. In RDG subzone = fixed value 1

Parameter	Name	Range	RDG400KN	RDG405KN	Dependencies
Diagnostics and test					
d01	Application number	0 = --- (no application) 1 = Single-duct 2 = Single-duct with electric heater 3 = Single-duct with radiator 4 = Single-duct with heating/cooling coil	✓	✓	
d02	X1 state	--- = No function (P38 = 0) 0 = Not activated (for DI) 1 = Activated (DI) 0...49 °C = Current temp. value (for AI) 00  = H/C input shorted 100  = H/C input open	✓	✓	
d03	U1 status (RDG405KN)	DC 0...10V; "---" means not available	✓	✓	
d04	D1 state	0 = Not activated (for DI) 1 = Activated (DI) 00  = H/C input shorted 100  = H/C input open	✓	✓	
d05	Test mode for checking the Y1/Y2 actuator's running direction ³⁾	"---" = No signal on outputs Y1 and Y2 OPE = Output Y1 forced opening CLO = Output Y2 forced closing	✓	✓	P46
d07	Software version	Ux.xx is displayed	✓	✓	

- This parameter can only be quit when the setting is back at "---".
Press the left button to escape

4. Handling

4.1 Mounting and installation

Do not mount on a wall in niches or bookshelves, behind curtains, above or near heat sources, or exposed to direct solar radiation. Mount about 1.5 m above the floor.

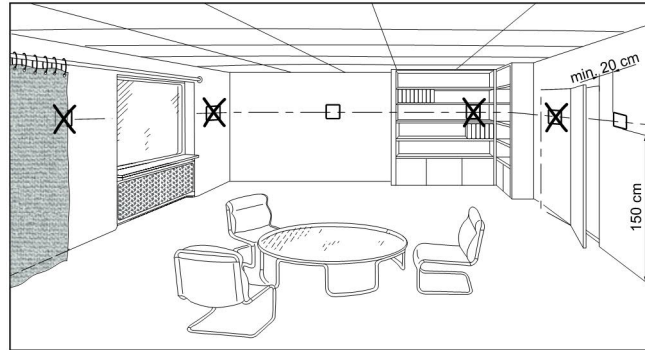

Mounting



- Mount the room thermostat in a clean, dry indoor place without direct air flow from a heating/cooling device, and not exposed to drip or splash water

Wiring

See Mounting Instructions M3192 [3] enclosed with the thermostat.



- Comply with local regulations to wire, fuse and earth the thermostat



- The power supply line must have an external fuse or circuit breaker with a rated current of no more than 10 A



- Isolate the cables of inputs X1-M, U1-G0 and D1-GND for AC 230 V if the conduit box carries AC 230 V mains voltage
- Inputs X1-M or D1-GND: Several switches (e.g. summer/winter switch) may be connected in parallel. Consider overall maximum contact sensing current for switch rating



- Isolate the cables of KNX communication input CE+/CE- for AC 230 V if the conduit box carries AC 230 V mains voltage
- Disconnect the unit from power supply before removing it from its mounting plate

4.2 Commissioning

Applications

The room thermostats are delivered with a fixed set of applications.

Select and activate the required application during commissioning using one of the following tools:

- Local DIP switch and HMI
- Synco ACS
- ETS

DIP switches

Set the DIP switches before snapping the thermostat to the mounting plate, if you want to select an application via **DIP switches**.

All DIP switches need to be set to OFF (remote configuration), if you want to select an application via **commissioning tool**.

After power is applied, the thermostat resets and all LCD segments blink, indicating that the reset was correct. After the reset, which takes about 3 seconds, the thermostat is ready for commissioning by qualified HVAC staff.

NO APPL

If all DIP switches are set to OFF, the display reads **NO APPL** to indicate that application commissioning via tool is required.

Note

Each time the application is changed, the thermostat reloads the factory setting for all control parameters, except for KNX device and zone addresses!

Connect tool

Connect the Synco ACS or ETS tool to the KNX bus cable at any point for commissioning:

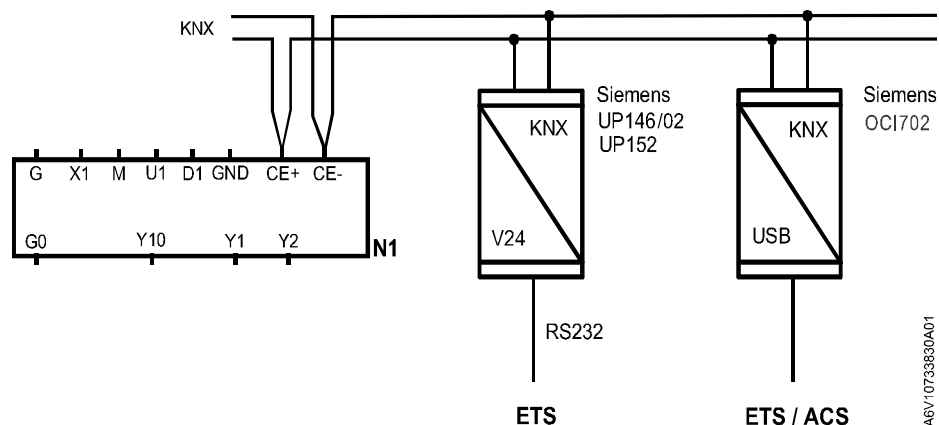

ACS and ETS require an interface:

- RS232 KNX interface (e.g. SiemensUP146/02, UP152)
- OCI702 USB-KNX interface

Note

An external KNX bus power supply is required if an RDG.. is connected directly to a tool (ACS or ETS) via KNX interface.

Control parameters

The thermostat's control parameters can be set to ensure optimum performance of the entire system (see section 3.11).

The parameters can be adjusted using ...

- the local HMI
- Synco ACS
- ETS

Control sequence

- The control sequence may need to be set via P01, depending on the application. The factory setting is as follows:

Application	Factory setting P01
Single-duct, single-duct with heating/cooling coil	1 = cooling only
Single-duct with electric heater, single-duct with radiator	Not adjustable

Recalibrating the sensor

- Recalibrate the temperature sensor if the room temperature displayed on the thermostat does not match the room temperature measured (after min. 1 hour of operation). To do this, change P05

Setpoint and range limitation

- We recommend to review the setpoints and setpoint ranges (P08...P12) and change them as needed to achieve maximum comfort and to save energy

Addressing mode

The addressing mode helps identify the thermostat in the KNX network during commissioning.

Press left and right buttons simultaneously for 6 seconds to activate addressing mode, which is indicated on the display with **PrOg**.

Addressing mode remains active until thermostat identification is complete.

Assigning the KNX device address

Assign the device address (P81) via HMI, ACS or ETS.

With device address set to 255, the communication is deactivated (no exchange of process data).

Assigning the KNX group addresses

Use ETS to assign the KNX group addresses of the thermostat's communication objects.

KNX serial number

Each device bears a unique KNX serial number at the rear.

An additional sticker with the same KNX serial number is enclosed in the packaging box. This sticker is intended for installers for documentation purposes.

4.3 Operation

See also Operating Instructions B3192 [2] enclosed with the thermostat.

Layout

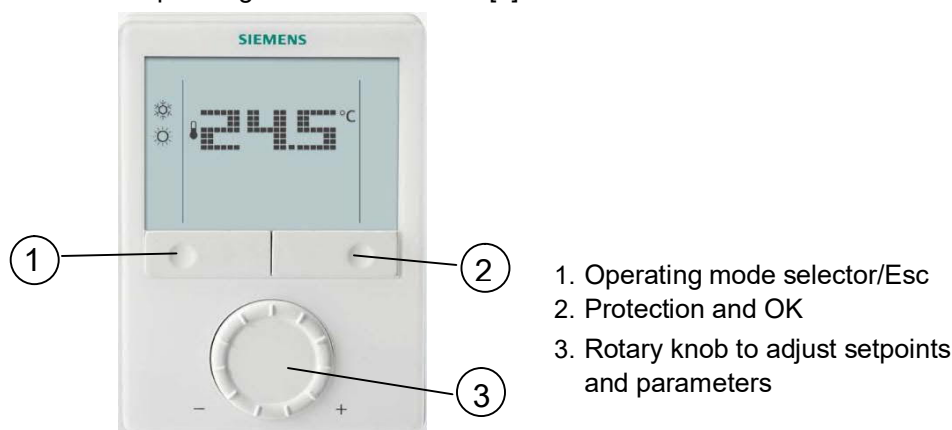

1. Operating mode selector/Esc
2. Protection and OK
3. Rotary knob to adjust setpoints and parameters

Button operation

User action	Effect, description
Normal operation	Actual operating mode and state are indicated by symbols.
Press any button (thermostat in normal operation)	Enter operating mode selection; backlit LCD turns on, all possible mode symbols turn on, indicator element (arrow) appears on the current mode/state.
Press left button	Change operating mode (indicator element (arrow) changes to the next mode symbol. After the last press and a timeout of 3 seconds, the newly selected mode is confirmed, the other elements disappear. After a timeout of 20 seconds, the LCD backlight turns off.
Press left button (P01 = 2)	Toggle between heating and cooling.
Press left button while "Operating mode" via bus is Economy or while operating mode switchover contact is activated	Activate "Extend Comfort mode" (for details, see page 20).
Keep left button depressed and turn rotary knob clockwise/counter-clockwise	Activate timer "Extend presence"/"Extend absence" and set the time (for details, see page 20).
Press right button >3 seconds	Activate/deactivate button lock.
Press right button	Set thermostat to Protection mode or back to the previous operation mode.
Turn rotary knob	Adjust the room temperature Comfort setpoint.
Hold down both the left and right buttons simultaneously for 4 seconds. Release them, and hold the right button again within 2 seconds until the temperature disappears	Enter parameter setting mode Service level.
Hold down both the left and right buttons simultaneously for 4 seconds. Release them, and hold the left button again within 2 seconds until the temperature disappears. Turn the rotary knob counterclockwise minimum 1/2 rotation. Pxx displays. Continue with step 2	Enter parameter setting mode "Expert level, diagnostics and test".
Press left and right button simultaneously for 6 seconds	Enter (KNX) programming mode.

Display

RDG400KN
RDG405KN

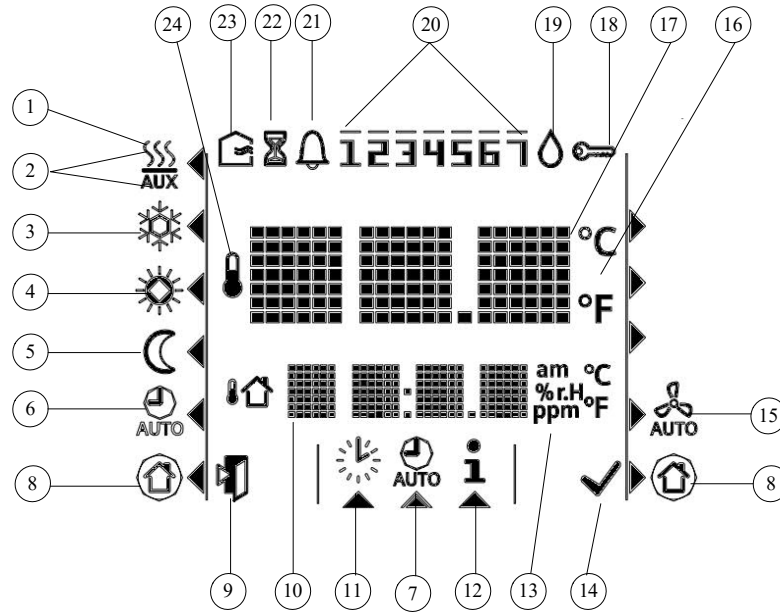

#	Symbol	Description	#	Symbol	Description
1		Heating mode	14		Confirmation of parameters
2		Heating mode, electric heater active	15		Primary fan is active (only supported with Synco700 primary controller)
3		Cooling mode	16		Degrees Celsius Degrees Fahrenheit
4		Comfort	17		Digits for room temperature and setpoint display
5		Economy	18		Button lock active
6		Auto Timer mode according to schedule (via KNX)	19		Condensation in room (dewpoint sensor active)
7		View and set Auto Timer program	20		Weekday 1...7 from KNX bus 1 = Monday/7 = Sunday
8		Protection mode	21		Fault
9		Escape	22		Temporary timer function; visible when operating mode is temporarily extended (extended presence or absence)
10		Additional user information, like outside temperature or time of day from KNX bus; selectable via parameters	23		Fresh air (RDG405KN)
11		Setting the time of day and the weekday	24		Indicates that room temperature is displayed
12		Information			
13		am and pm: Real time clock in either 24- or 12-hour (am/pm) mode ppm: CO ₂ external sensor value (RDG405KN)			

4.4 Remote operation

The RDG.. room thermostats can be operated from a remote location using an OZW772/OZW775 web server or the ACS tool.

4.5 Disposal



The device is considered electrical and electronic equipment for disposal in terms of the applicable European Directive and may not be disposed of as domestic garbage.

- Dispose of the device through channels provided for this purpose.
- Comply with all local and currently applicable laws and regulations.

5. Supported KNX tools

5.1 ETS



ETS

ETS is an engineering tool used to fully commission the RDG4..KNX room thermostats.

ETS can implement the following functions:

- Defining and downloading the physical address
- Defining and downloading the application (plant type, control sequence)
- Setting up and downloading the thermostat's control parameters
- Setting up and downloading group addresses

This Basic Documentation does not describe how to operate the ETS tool and commission a device. Refer to the KNX Manual for more details.



Note

Addressing mode

Setting RDG..KNX parameters is only supported by ETS4 or higher!

To start KNX programming, press left and right button simultaneously for at least 6 seconds.

5.1.1 Parameter settings in ETS

1. Open the project in ETS and select a device.
2. Click **Parameters** tab, and adjust the control parameters as follows:

0.2.1 RDG405KN Room Thermostat > Basic configuration

Basic configuration	[DIP] Plant type	Single duct
Device	[P01] Control sequence	Cooling only
Room operating mode		
Room temperature and setpoi...		
Controller		
Terminal inputs		
Indoor air quality		

3. The **Plant type** (application), **Control Sequence** and other control parameters ([Pxx] description) can be downloaded.

Notes

ETS 4 or higher version is used to download the application and parameters

IAQ control (RDG405KN only)

1. Select if the CO₂ (or VOC) sensor is to transmit (DC input) or receive from another KNX device.
2. Set the setpoint and the P-band (Xp)

Basic configuration	Group communication objects
Device	Indoor air quality: CO2 concentration <input checked="" type="radio"/> Transmit <input type="radio"/> Receive
Room operating mode	
Room temperature and setpoi...	Parameter settings
Controller	[P19] Air quality setpoint 1000 [ppm]
Terminal inputs	[P20] Indoor air quality P-band Xp 400 [ppm]

Indoor air quality

Object 44 can be used to transmit or receive the IAQ value.

Number	Name	Object Function	De	Gr	Length	C	R	W	T	U	Data Type
44	Indoor air quality: CO2 concentration [ppm]	Receive			2 bytes	C	-	W	-	U	parts/milli...

5.2 ACS790



With the ACS790 tool, the RDG..KNX room thermostats can be commissioned (physical address, application, parameters). They can be operated or monitored via bus during normal operation.

This Basic Documentation not describe how the physical address is defined. Also, it only gives a brief overview of the main functionality of the ACS tool. For more information, refer to ACS online help.



Setting RDG..KNX parameters is only supported by ACS version 5.11 or higher!

5.2.1 Parameter settings in ACS

In the **ACS tool**, select **Plant**, then **Open** to open the plant. To start the parameter settings, select **Applications**, then **Parameter settings...**:

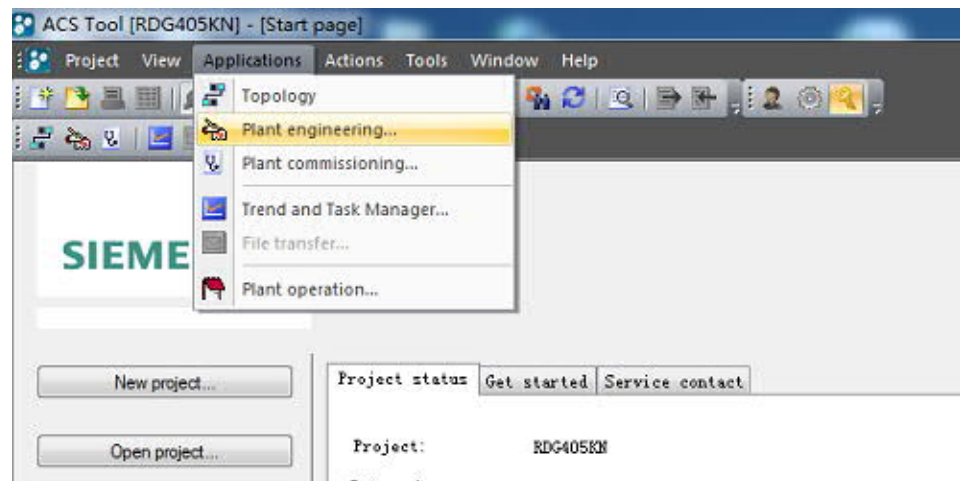

The **application** and **control parameters** can be adjusted and downloaded. Column *Line no.* contains the parameter number as shown in the parameter table (see section 3.11).

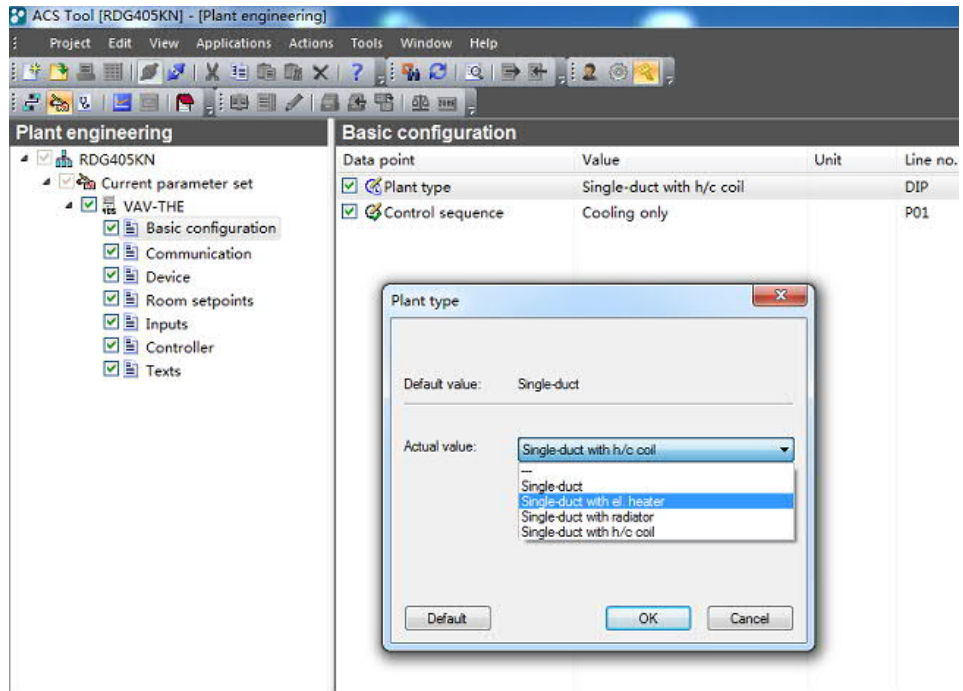

5.2.2 Operation and monitoring with ACS



In the **ACS tool**, select **Plant**, then **Open** to open the plant.

To start monitoring and operation, select **Applications**, then **Plant operation – Standard popcard**

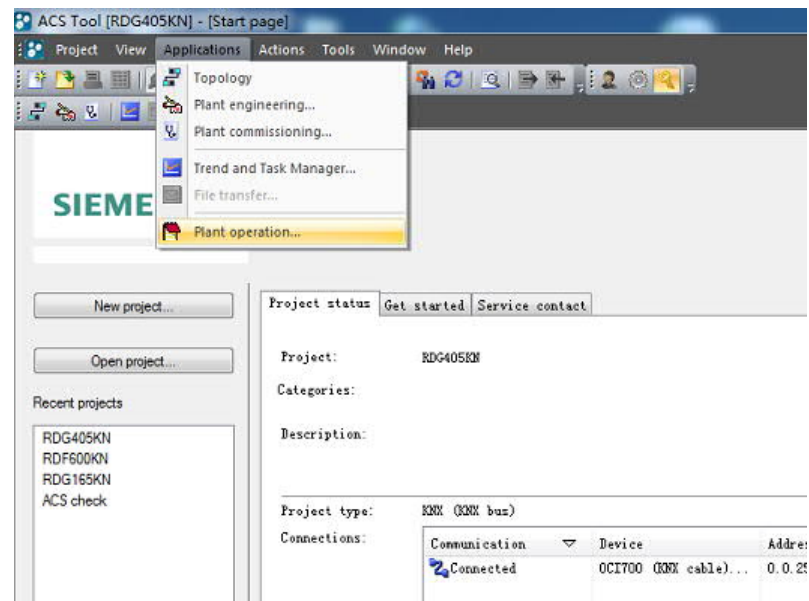

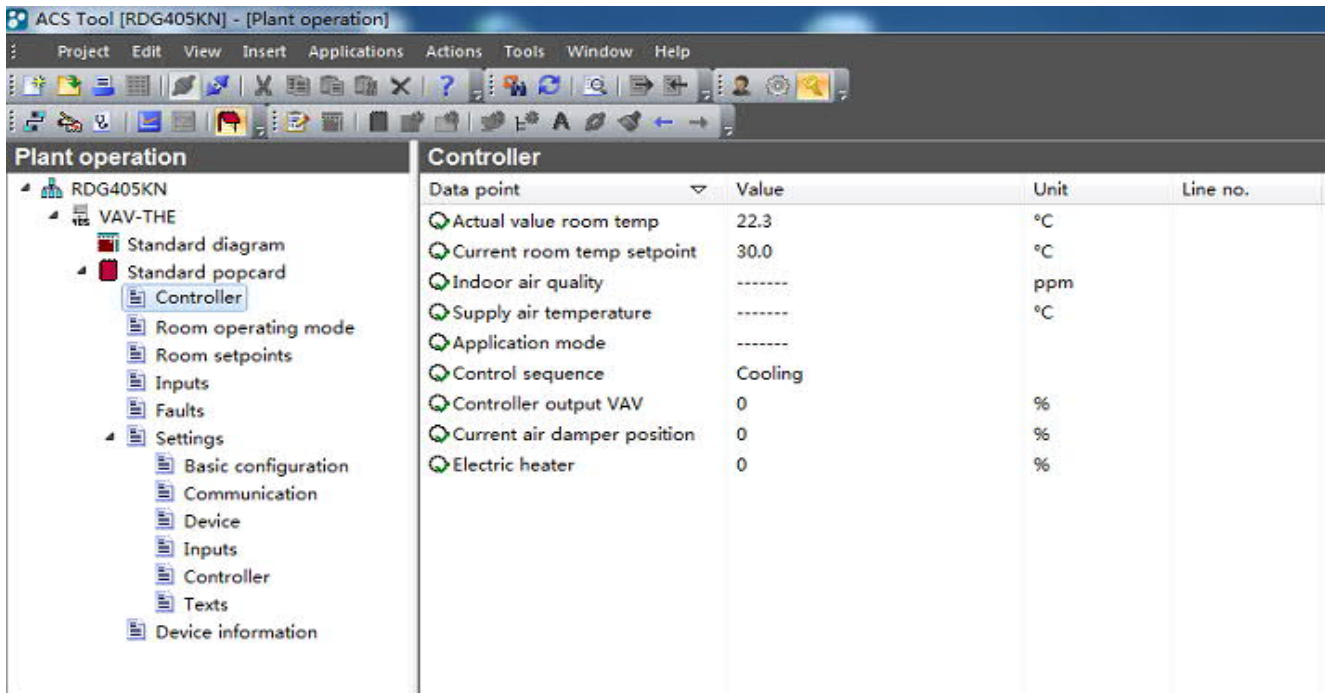

Parameter settings in ACS

The ACS tool supports parameter settings even during normal operation. To change a control parameter, select **Applications**, then **Plant operation**.

Notes

- Make sure you have logged on with sufficient access right
- Only control parameter can be changed, no application!

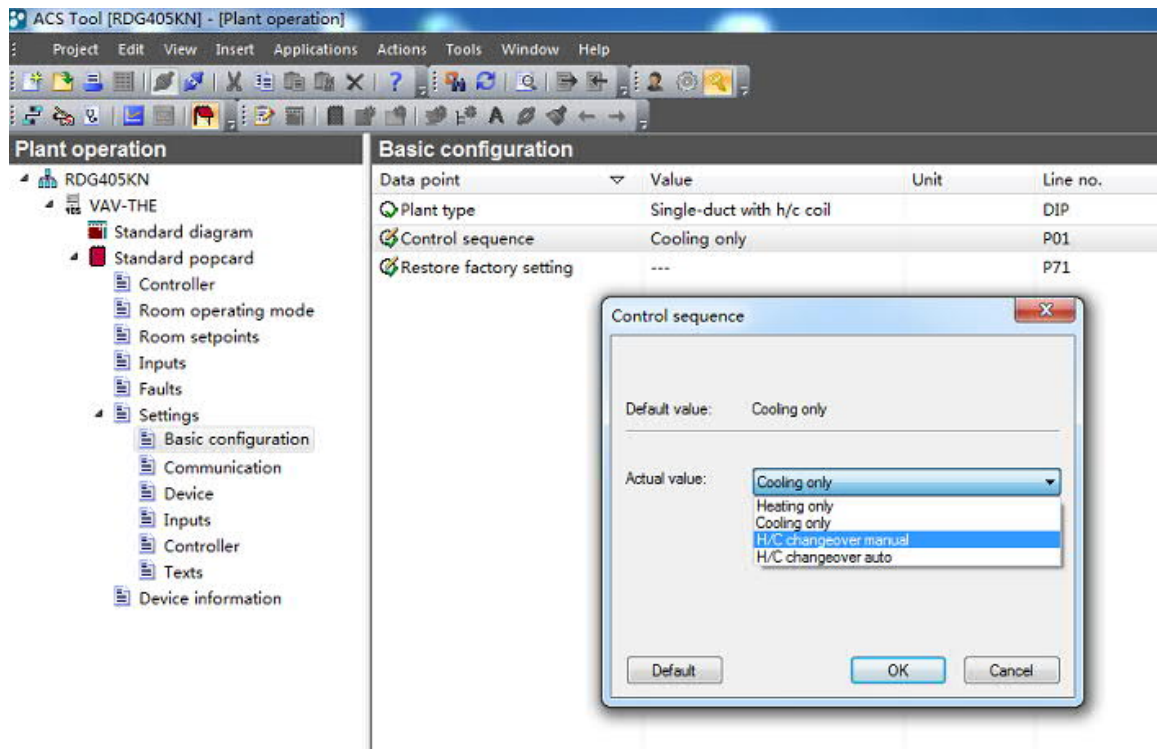

Plant diagram in ACS

The ACS tool offers **plant diagrams** for easy monitoring and operation of the thermostat. To start this application, select **Standard diagram**.

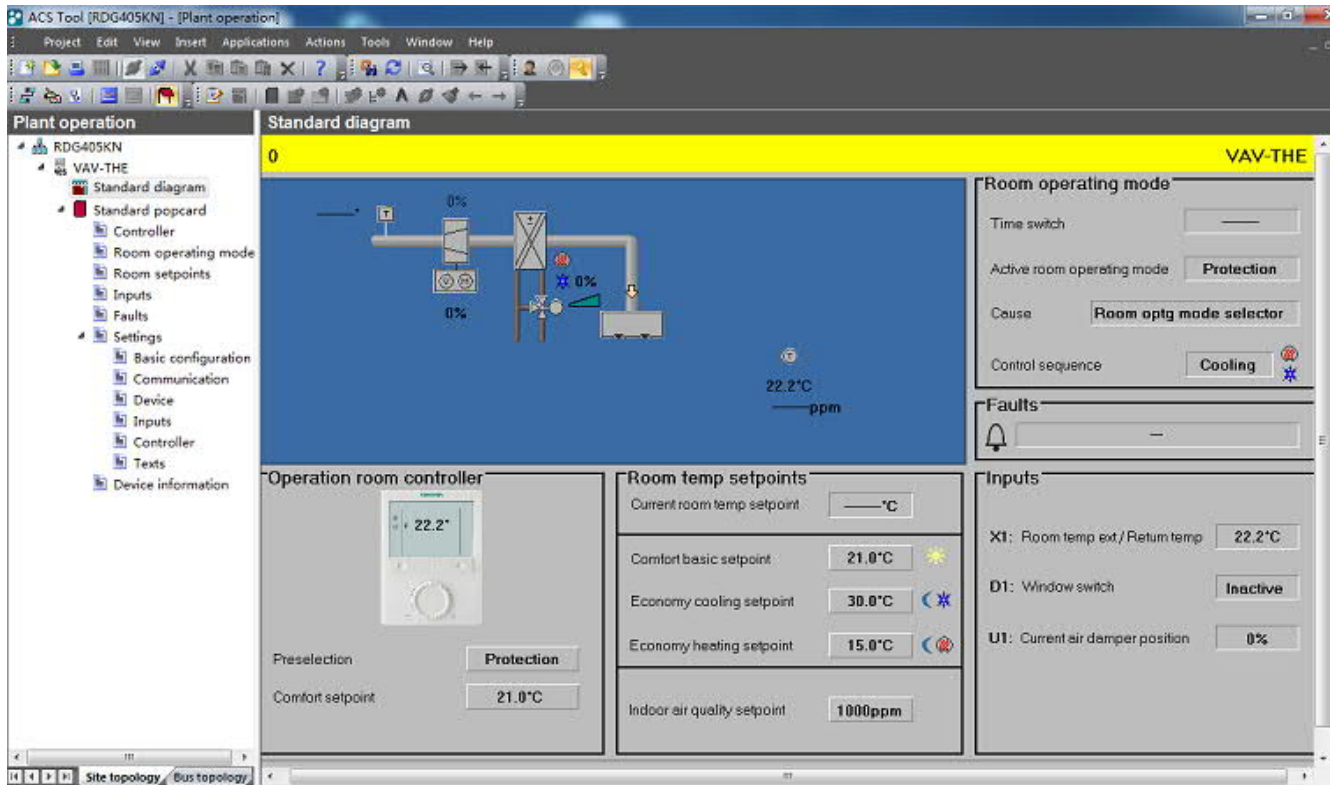

The ACS tool provides standard plant diagrams for RDG..KNX room thermostats, which depend on the configuration as follows:

Plant type	Application
Single-duct	
Single-duct with electric heater	
Single-duct with radiator	
Single-duct with heating/cooling coil	

5.2.3 Operation and monitoring with OZW772

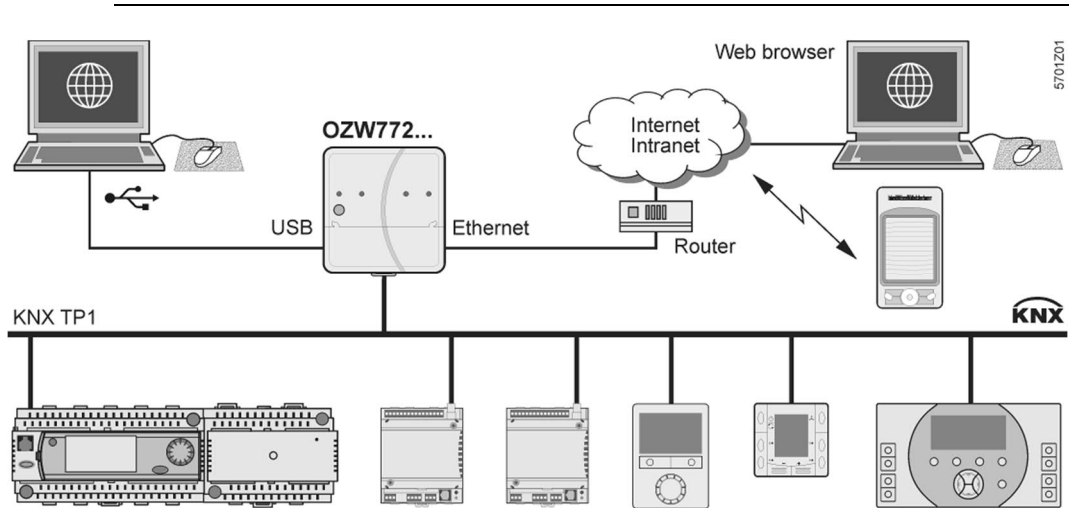

The OZW772 web server enables users to operate a Synco HVAC system from a remote location – via PC or from a smartphone via the web. A start page shows the most important data points. A combination of menu/path navigation enables users to access all data points quickly and straightforwardly. The entire installation can be visualized in the form of plant diagrams. Alarm and state messages can be forwarded to different message receivers, such as e-mail, SMS, etc.

For details, refer to Commissioning Instructions CE1C5701.

6. Connection

6.1 Connection terminals

G	X1	M	U1	D1	GND	CE+	CE-	G, G0	Operating voltage AC 24 V
G0	Y10	Y1	Y2					Y10-G0	Control output for DC 0...10 V actuator
								Y1-G0, Y2-G0	Control outputs for 2-position, PWM or 3-position actuators
								X1	Multifunctional input for temperature sensor (e.g. QAH11.1) or potential-free switch Factory setting: External temperature sensor (function can be selected via P38)
								M	Measuring neutral for sensors and switches
								U1	DC 0...10 V input for actual air damper position DC 0...10 V input for CO ₂ sensor (0...2000 ppm) (RDG405KN) (Note: G0 is the measuring neutral for U1!)
								D1-GND	Multifunctional input for potential-free switch. Factory setting: Operating mode switchover contact (function can be selected via P42)
								CE+	KNX data +
								CE-	KNX data –

6.2 Connection diagrams

Application

Single-duct

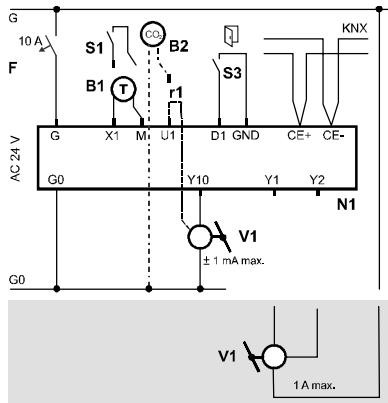

KNX V1

Single-duct with electric heater, radiator or heating/cooling valve

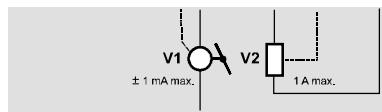

KNX V1

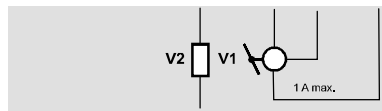

KNX V1

- N1 Room thermostat RDG4..KN
- V1 Damper actuator or VAV compact controller: DC 0...10 V or 3-position, VAV compact controller KNX
- V2 Electric heater, radiator or heating/cooling valve: DC 0...10 V, 2-position, PWM or 3-position
- S1 Switch (keycard, window contact, etc.)
- U1 DC 0...10 V input feedback signal for current air damper position
DC 0...10 V input for CO₂/VOC sensor (0...2000 ppm) (RDG405KN)
- S3 Switch at SELV input (keycard, window contact)
- B1 Temperature sensor (return air temperature, external room temperature, changeover sensor, etc.)
- B2 CO₂ sensor (0...2000 ppm) (RDG405KN)
- CE+ KNX data +
- CE- KNX data -

7. Mechanical design

7.1 General

The room thermostat consists of 2 parts:

- Plastic housing with electronics, operating elements and room temperature sensor
- Mounting plate with the screw terminals

The housing engages in the mounting plate and is secured with 2 screws.

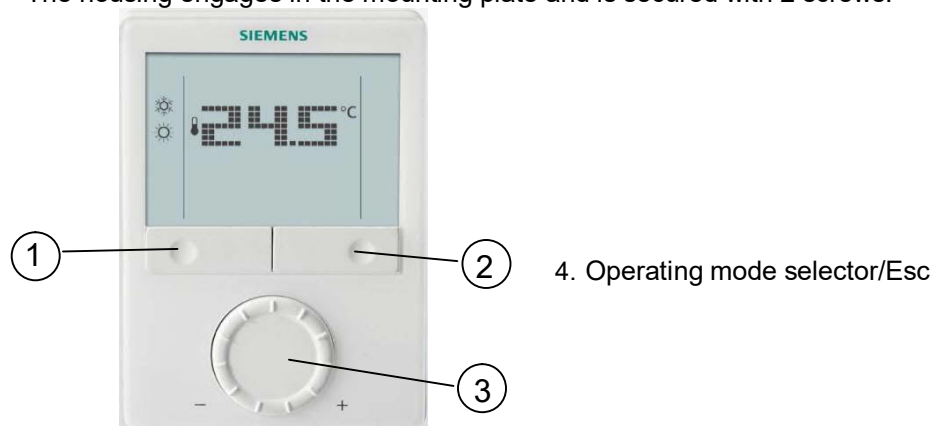

For operation, refer to section 4.3.

7.2 Dimensions

Dimensions in mm

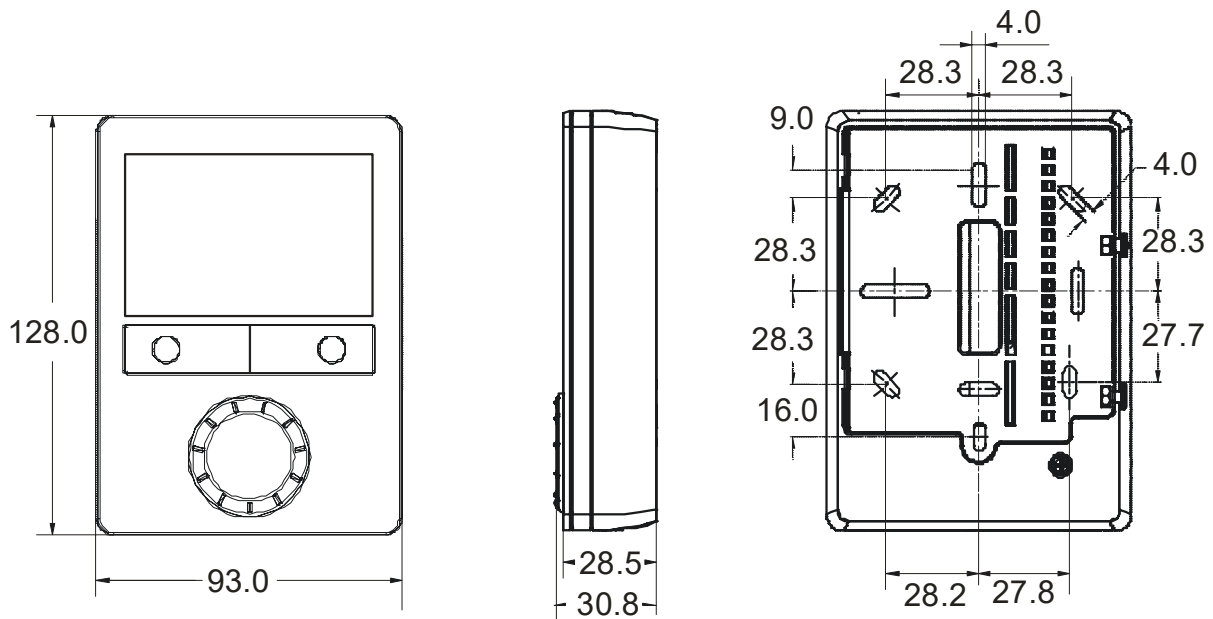

8. Technical data

 Power supply



Operating voltage	SELV AC 24 V ±20%
Rated voltage	AC 24 V
Frequency	50/60 Hz
Power consumption	Max. 2 VA/1 W

No internal fuse!

In all cases, external preliminary protection with a circuit breaker max. C 10 A is required.

Outputs

Control output Y10-G0	DC 0...10 V
Resolution	39 mV
Current	Max. ±1 mA
Control output Y1, Y2-G	AC 24 V
Rating	Max. 1 A
Power limitation	3 A fast microfuse (cannot be exchanged)

Inputs





Multifunctional inputs	
X1-M	
Temperature sensor input	
Type	QAH11.1 (NTC)
Temperature range	0...49 °C (32...120 °F)
Cable length	Max. 80 m
Digital input	
Operating action	Selectable (NO/NC)
Contact sensing	DC 0...5 V, max. 5 mA
Parallel connection of several thermostats for one switch	Max. 20 thermostats per switch. Do not mix with D1!
U1-G0	
Input for actual air damper position feedback	DC 0...10 V, max. 0.3 mA
damper position 0%(fully closed)	0...100%
100% (fully open)	DC 0...10 V, max. 0.3 mA
Input for external CO ₂ /VOC sensor (RDG405KN)	0... 2000 ppm
Selectable (NO/NC)	
D1-GND	
Operating action	SELV DC 6...15 V, 3...6 mA
Contact sensing	Max. 20 thermostats per switch. Do not mix with X1!
Parallel connection of several thermostats for one switch	
Function of inputs	
Selectable	
External temperature sensor, heating/cooling changeover sensor, operating mode switchover contact, dewpoint monitor contact, enable electric heater contact, fault contact, monitoring input	X1: P38 D1: P42

KNX bus

Interface type	KNX, TP1-64 (galvanically separated)
Bus current	5 mA
Bus topology: Refer to KNX Manual (see reference documentation)	

Operational data

Switching differential (adjustable)		
Heating mode	(P30)	2 K (0.5...6 K)
Cooling mode	(P31)	1 K (0.5...6 K)
Setpoint setting and setpoint range		
☀ Comfort	(P08)	21 °C (70 °F) (5...40 °C) (41...104 °F)

	 Economy (P11-P12)	15 °C/30 °C (59°F/86 °F) (OFF, 5...40 °C)
	 Protection (P65-P66)	8 °C/OFF (OFF, 5...40 °C)
	Multifunctional inputs X1-D1	Selectable (0...8)
	Input X1 default value (P38)	1 (ext. temperature sensor, room or return air)
	Input D1 default value (P42)	3 (operating mode switchover)
	Built-in room temperature sensor	
	Measuring range	0...49 °C (32...120 °F)
	Accuracy at 25 °C (after calibration via P05)	< ± 0.5 K ± 3.0 K
	Temperature calibration range	
	Settings and display resolution	
	Setpoints	0.5 °C (33 °F)
	Current temperature value displayed	0.5 °C (33 °F)
Environmental conditions	Operation	IEC 721-3-3
	Climatic conditions	Class 3K5
	Temperature	0...50 °C (32...122 °F)
	Humidity	<95% r.h.
	Transport	IEC 721-3-2
	Climatic conditions	Class 2K3
	Temperature	-25... 60 °C (-77...140 °F)
	Humidity	<95% r.h.
	Mechanical conditions	Class 2M2
	Storage	IEC 721-3-1
	Climatic conditions	Class 1K3
	Temperature	-25... 60 °C (-77...140 °F)
	Humidity	<95% r.h.
Standards and directives	 conformity to EMC directive	CE1T3192xx *)
	 RCM conformity	CE1T3192en_C1
	Safety class	III as per EN 60730
	Pollution class	Normal
	Degree of protection of housing	IP30 as per EN 60529
General	Connection terminals	Solid wires or stranded wires with ferrules 1 x 0.4...2.5 mm ² or 2 x 0.4...1.5 mm ²
	Housing front color	RAL 9003 white
	Weight without/with packaging	0.237 kg/0.360 kg

Index

3

- 3-position control signal 47
- 3-position for air flow 47

A

- Absence 20
- ACS 76
- Addressing mode 72, 75
- Air demand 58
- Air heating/cooling changeover 31
- Applications overview 29
- Automatic heating/cooling changeover 31, 33
- Automatic heating/cooling changeover via bus 31

B

- Bus - set operating modes 21
- Bus - setting and adjusting setpoints 27
- Bus power supply 71
- Button lock 33

C

- Cable length for sensors 52
- Changeover switch 31
- Changeover via KNX 31, 51
- Commissioning 18, 27, 29, 59, 65, 71
- Communication objects 53, 61
- Communication objects LTE 64
- Connecting a KNX tool 66
- Control output VAV 58
- Control outputs configuration 50
- Control outputs overview 47
- Control parameters 65
- Control sequences 33
- Cooling demand 58
- Cooling sequence 33

D

- DC 0... 10 V control signal 47
- DC 0... 10 V for air flow 47
- DC 0... 10 V for electric heaters 48
- Desigo 10
- Dewpoint monitoring 32, 51
- Digital input 51
- DIP switches 29, 47, 50, 71
- Disposal 75
- Download via tool 66

E

- Effect of Protection via time schedule 19
- Electric heater 38

- Enable/disable electric heater 38, 52
- Expert level parameters 65
- Extension of presence/absence 20
- External sensors 46
- External/return air temperature 51, 53
- External/return air temperature sensor 32
- Extract air 30

F

- Fan (primary) 38, 52, 58
- Fan overrun time 38
- Fault 52
- Fault on KNX 59
- Fault, handling 53
- Floor temperature limitation function 32

G

- Geographical zone 55

H

- Heartbeat 57
- Heating demand 58
- Heating sequence 33
- Heating/cooling changeover 51

I

- IAQ 14
- Integral action time 13
- Integration via KNX 9

K

- KNX addressing 72
- KNX bus power supply 71
- KNX functions 9
- KNX LTE-Mode 53
- KNX overview 6, 53
- KNX parameters 75
- KNX serial number 72
- KNX S-Mode 53

L

- LTE-Mode 53

M

- Manually select heating or cooling sequence 33
- Monitoring with ACS 77
- Monitoring with OZW772 81
- Mounting and installation 70
- Multifunctional inputs 51

O			
On/Off control signal	47	Reset parameters.....	65
Operating mode		S	
Priority intervention.....	18	Sensor input.....	51, 53
Operating mode - setting via bus.....	21	Setpoint Comfort mode.....	45
Operating mode button	19	Setpoint Economy mode.....	45
Operating mode switchover.....	51	Setpoint limitation	25
Operation with ACS	77	Setpoint Protection mode	45
Operation with OZW772.....	81	Setpoints - setting via bus.....	27
Outside (air) temperature.....	56, 63, 74	Setpoints and sequences	45
OZW772.....	81	S-Mode	53
P		Standby/Protection mode	17
Parallel connection of switches	52	Supply air temperature	31
Parameter setting	65	Supply and extract air.....	30
Parameter setting via tool	66	Switching differential.....	13
Parameter settings in ACS.....	76, 78	Synchronization.....	47, 49
Parameter settings in ETS	75	Synco 700, Synco living.....	9
Precomfort.....	19	T	
Presence	20	Temperature out of range	53
Presence detector.....	20	Temporary setpoint.....	25
Primary fan.....	38, 52, 58	Time of day via KNX.....	14
Proportional band	13	Time schedule change mode.....	19
Protection mode/standby	17	Tool - Parameter setting and download.....	66
PWM	47	V	
PWM for electric heaters.....	49	VAV changeover.....	31
R		VAV changeover via bus.....	33
Radiator.....	41	W	
Remote heating/cooling changeover	31	Window state.....	17, 18, 51
Remote operation	81		