

## Smart Thermostat

RDS110



To control heating applications in apartments, single family homes, dormitories, and other residential as well as commercial spaces.

- Backlit, auto-dimming 90 mm color LCD touch screen for intuitive local operation
- Mobile app for smartphones
- Patented<sup>1)</sup> self-learning algorithm with PID response
- Green leaf button for energy-optimized operation
- Air quality indication via built-in sensor
- Operate automatically following a scheduler
- Multifunctional inputs for window contacts, remote sensors, etc.
- Two relay outputs for heating equipment, humidifier, dehumidifier or domestic hot water boiler
- Satisfy EU.BAC certification level AA for Home Control and Class IV according to the Eco design directive

1) Patent pending

## Room thermostat features

- Direct temperature and operating mode selection
- RoomOptiControl function with Green leaf  button for energy-optimized operation
- Air quality indication: “Good”, “Okay”, “Poor”
- Temperature setting limitation for use in public spaces
- Screen lock protection against unauthorized access
- Manual switchover between “At home”, “Away” and “OFF” on touch screen
- Room temperature control using the built-in temperature sensor or an optional remote sensor
- Optional temperature averaging using an additional remote temperature sensor
- Patented self-learning algorithm with PID response (patent pending) guaranteeing optimum temperature control performance in all room types
- Optimum start control function that advances the switch-on time to ensure the selected setpoint is reached as required
- Floor temperature limitation using a remote sensor in electric floor-heating applications
- Humidity control using the built-in humidity sensor or an optional remote sensor
- Presence detection using a built-in PIR sensor or approach sensor
- Two multifunctional inputs, optional and configurable for:
  - Operating mode switchover contact (e.g. window contact)
  - Remote room temperature sensor
  - Floor temperature sensor
  - Outside air temperature sensor
  - Remote humidity sensor
- Two relay outputs for:
  - Heating equipment (see “Use” for examples)
  - Extra output for domestic hot water (DHW) boiler, humidifier or dehumidifier
- Periodic pump/valve operation to protect against seizing
- Navigation wizard for guided, fast commissioning
- Remote firmware upgrade capability

\*) The Green leaf indication informs the user that the system provides energy-optimized operation. When the leaf is red, the thermostat setting has been changed. Touch the red leaf to return the setting to energy-optimized operation. See the user guide for more information on this function.

## Remote operation and monitoring

- Mobile app for smartphones based on iOS and Android operating systems
- Support “Dark” and “Light” background colors on mobile app
- Manual switchover between “At home”, “Away” and “OFF” operating modes on mobile app
- Individual scheduler for each day of the week can be programmed via mobile app with the following operating modes (max. 5 modes per day)
  - “Comfort”: To enjoy comfort and coziness when you are at home.
  - “Economy”: To save energy when maximum comfort is not required, e.g. in the evening or at night.
  - “Unoccupied”: To save energy costs by reducing the temperature setpoint, e.g. when the room is unoccupied.
- Individual scheduler for domestic hot water boiler
- User account management

- Monitoring of temperature and humidity
- Monitoring of indoor air quality: “Good”, “Okay”, “Poor”
- Secure access and data transmission with the Siemens Cloud Computing Platform

## Use

The RDS110 is designed to control heating applications in apartments, single family homes, dormitories, and other residential as well as commercial spaces.

RDS110 controls the following plant components:

- Gas boiler
- Radiator with valve
- Radiator with pump
- Electric floor heating
- Fan with electric heating
- Floor heating with valve
- Floor heating with pump
- Electric radiator
- Electric boiler
- Generic heating device

In addition, an external relay is available to optionally control a domestic hot water (DHW) boiler, humidifier or dehumidifier.

Two multifunctional inputs, optional and configurable for:

- Operating mode switchover contact (e.g. for a window contact)
  - The operating mode can change according to contact status.
- Remote room temperature sensor
  - The remote temperature sensor can acquire the current room temperature. If the sensor input signal is lost, the thermostat controls the room according to the internal sensor.
- Floor temperature sensor
  - The floor heating limitation function prevents the floor temperature from exceeding a preset value.
- Outside air temperature sensor
  - The outside air temperature sensor can acquire outside air temperature information for display on touch screen.
- Remote humidity sensor
  - The thermostat can control a standalone humidifier or dehumidifier. The relative humidity is measured by the remote humidity sensor or internal humidity sensor.

## Mechanical design

The room thermostat consists of the following parts:

- Housing front with touch screen and sensors
- Housing rear with terminals and relays
- Metallic mounting plate for wall mounting
- Accessories

Normal display

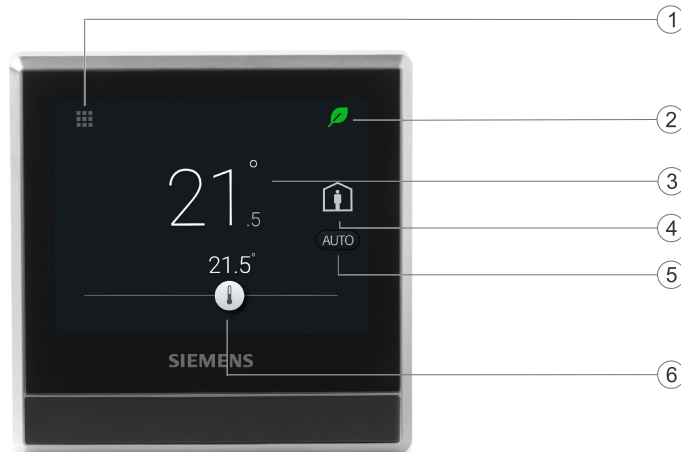

- 1 Tap to display detailed information and additional setting possibilities.
- 2 Shows if the system is in an energy-optimized mode. If the leaf is red, predefined settings were changed. Tap the red leaf to restore energy-saving mode. The leaf again turns green.
- 3 Room temperature\*)
- 4 Tap to toggle between “At home” and “Away”.
- 5 Shows if the thermostat works automatically (☰) or manually (☷). Using a scheduler can mean the following:
  - If there is Cloud connection and the scheduler has already been set, the thermostat follows the scheduler. A temporary change of the temperature setpoint only takes effect during the currently scheduled mode.
  - If there is Cloud connection, but no scheduler has been set, the thermostat follows the default scheduler set by the system.
  - If there is no Cloud connection, the thermostat cannot retrieve scheduler information.
- 6 Temperature setpoint slider. Icon color changes as setpoint is changed.
  - If you increase the setpoint by dragging the slider to the right to warm up the room, the slider color changes to orange.
  - If no heating occurs, the slider color changes to white.

<b>!</b>	<b>NOTICE</b>
	After initial setup of the thermostat, the displayed room temperature may not be correct because the temperature sensors need time for calibration. Wait for at least one hour for the calibration.

## Idle display



- 1 Room relative humidity
- 2 Shows room air quality:
  - If the icon is green, air quality is good.
  - If the icon is orange, air quality is okay.
  - If the icon is red, air quality is poor.
- 3 Shows if the system is in an energy-optimized mode. If the leaf is red, predefined settings were changed. Tap the red leaf to restore energy-saving mode. The leaf again turns green.
- 4 Room temperature

**Note:** Depending on how the thermostat is set up, the displayed options in idle mode may differ.

## Type summary

Product number	Stock number	Description
RDS110	S55772-T100	Room thermostat

## Ordering

- When ordering, indicate product number, stock number and description.
- Order valve actuators separately.

## Inbox items

Items	Quantity
Thermostat (front and rear)	1
Metallic mounting plate	1
Set of screws and plastic insert	1
Quick guide	1

Items	Quantity
Mounting instructions	1
Activation code sticker	1
Wiring sticker	1

## Equipment combinations

### Remote sensors







Type of unit	Product no.	LG-Ni1000 at 0 °C	Pt1000 at 0 °C	NTC 10k at 25 °C	DC 0...10 V	Datasheet*
Room temperature sensors						
- Wall-mounted	QAA24	x				1721
	QAA2012		x			1745
	QAA2030			x		1745
	QAA2061				x	1749
	QAA2061D <sup>2)</sup>				x	1749
- Flush-mounted <sup>1)</sup>	AQR2531ANW	x				1408
	AQR2532NNW				x	1411
- Concealed	QAA64 (vandal-proof)	x				1722
Outdoor temperature sensors						
	QAC22	x				1811
	QAC2012		x			1811
	QAC2030			x		1811
	QAC3161				x	1814
Cable temperature sensors						
	QAP21.3	x				1832
	QAP22	x				1831
	QAP21.3/8000	x				1832
	QAP2012.150		x			1831
	QAP1030.200			x		1831

Type of unit	Product no.	LG-Ni1000 at 0 °C	Pt1000 at 0 °C	NTC 10k at 25 °C	DC 0...10 V	Datasheet*
Room humidity sensors						
- Wall-mounted	QFA2000				x	1857
- Wall-mounted including temperature	QFA2020	x (T)			x (r.h.)	1857
	QFA2060				x (T+r.h.)	1857
	QFA2060D <sup>2)</sup>				x (T+r.h.)	1857
- Flush-mounted <sup>1)</sup> including temperature	AQR2534ANW + AQR2540Nx	x (T)			x (r.h.)	1410
	AQR2535NNW + AQR2540Nx				x (T+r.h.)	1410

\* The documents can be downloaded from <http://siemens.com/bt/download> by specifying the product number as shown in the above table.

- 1) Requires a mounting plate and/or design frames.  
2) With digital display.

### Actuators

Type of unit		Product no.	Datasheet*
Electromotoric actuator		SFA21/18	4863
		SUA21/3	A6V10446174
Electrothermal actuator (for radiator valves) AC 230 V, NO		STA23..	4884
Electrothermal actuator (for radiator valves) AC 24 V, NO		STA73..	4884
Electrothermal actuator AC 230 V (for small valves 2.5 mm), NC		STP23..	4884
Electrothermal actuator AC 24 V (for small valves 2.5 mm), NC		STP73..	4884

### Accessory

Type of unit		Product no.	Datasheet*
White decoration frame and metallic mounting plate for installation on rectangular conduit box (1 set)		ARG100.01 S55772-T102	A6V11190640

\* The documents can be downloaded from <http://siemens.com/bt/download> by specifying the product number as shown in the above table.

## Product documentation

Topic	Title	Document ID
Mounting and installation	Mounting instruction	A5W90001424
Installation and operation	User guide	A6V10877569
Startup wizard	Quick guide	A5W90001422
CE declaration		A5W90002476
Product environmental declaration		A5W90003412

Related documents such as environmental declarations, CE declarations, etc., can be downloaded at: <http://siemens.com/bt/download>.

## Notes

### Security

	<b>⚠ CAUTION</b>
	<b>National safety regulations</b> Failure to comply with national safety regulations may result in personal injury and property damage <ul style="list-style-type: none"><li>• Observe any national provisions and comply with the appropriate safety regulations.</li></ul>

### Engineering

See the product documentation for information on engineering, selection and sizing connecting cables for supply voltage and field devices.

### Installation

The mounting plate of the thermostat can be installed on CEE/VDE conduit boxes and on square boxes 75 x 75 mm. For installation on a rectangular conduit box (e.g. 105 x 72 mm), accessory ARG100.01 must be ordered, which includes 1 set of white decoration frame and bigger mounting plate.

	<b>⚠ WARNING</b>
	<b>No internal line protection for supply lines to external consumers</b> Risk of fire and injury due to short-circuits <ul style="list-style-type: none"><li>• Adapt the line diameters as per local regulations to the rated value of the installed overcurrent protection device.</li><li>• The AC 230 V mains supply line must have an external circuit breaker with a rated current of no more than 10 A.</li><li>• Properly size the cables to the thermostat and for the outputs for AC 230 V mains voltage.</li><li>• Use only AC 230 V isolated wired cables, as the conduit box carries AC 230 V mains voltage.</li><li>• Remove wired bridge L - Q11 when loads work with voltages other than AC 230 V.</li><li>• Inputs X1-M-X2: Several switches (e.g. window contact) may be connected in parallel. Consider overall maximum contact sensing current for switch rating.</li><li>• Disconnect from power supply before removing the front of the thermostat.</li></ul>



## Commissioning

Refer to the Quick guide and User guide (see Product Documentation) to configure your device. Commissioning includes the following:

- Internet connection
- Application setup
- Account registration and device pairing

### Note:

Before configuring your thermostat, make sure you are connected to the Internet, have a valid email address, and a smartphone.

## Mounting

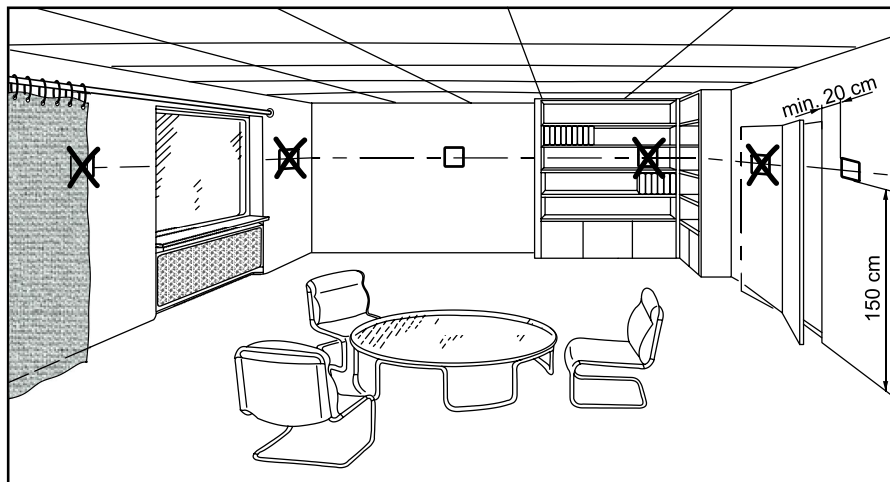

- The devices are suitable for wall mounting.
- Recommended height: 1.50 m above the floor.
- Do not mount the devices in recesses, shelves, behind curtains or doors, or above or near heat sources.
- Avoid direct solar radiation.
- Seal the conduit box or the installation tube if any, as air currents can affect sensor readings.
- Adhere to allowed ambient conditions.

## Operation

End users can operate the thermostat directly on the touch screen, or download the mobile app “Siemens Smart Thermostat RDS” and perform operations on their smartphones, including:

- Creating and managing accounts
- Setting the operating mode (Auto, away, home, manual)
- Changing the room temperature (by setting new setpoints)
- Setting a weekly scheduler (heating and domestic hot water)
- Green leaf (switching to energy-optimized operation)

Supported smartphone types are as follows:

### Operating system

OS	OS version	App store
iOS	iOS 10 or above	App store®
Android	Android™ 5.0 or above	Google Play™

## Maintenance

---

The thermostat is designed for maintenance-free operation.

## Disposal

---



The device is considered an electronic device for disposal in accordance with the European Guidelines and may not be disposed of as domestic garbage.

- Dispose of the device through channels provided for this purpose.
- Comply with all local and currently applicable laws and regulations.

## Warranty

Technical data on specific applications are valid only together with Siemens products listed under "Equipment combinations". Siemens rejects any and all warranties in the event that third-party products are used.

## Radio equipment directive

---

The equipment is using harmonized frequency in Europe, and also compliances with the Radio Equipment Directive (2014/53/EU, formerly 1999/5/EC).

**Power supply**

Power supply	
Operating voltage	AC 230 V (+10% / -15%)
Frequency	48...63 Hz
Power consumption	Max. 9 VA
Standby power consumption (LCD off)	0.6 W
Max. external supply line fusing	10 A circuit breaker

**Radio parameters**

Radio parameters	
Frequency band	2.4...2.4835 GHz
Maximum radio-frequency power	18 dBm
WLAN standard	IEEE 802.11b/g/n (HT20)
WLAN channel	1~13

**Inputs**

Connections to multifunctional inputs X1 - M - X2	
Passive temperature sensors - Cable length max. (copper cable section)	90 m (1.5 mm <sup>2</sup> wire), 70 m (1 mm <sup>2</sup> wire) 60 m (0.75 mm <sup>2</sup> wire), 40 m (0.5 mm <sup>2</sup> wire)
- NTC type	NTC10K at 25 °C
Room temperature range	0...50 °C
Outdoor temperature range	-50...80 °C
- Ni type	Ni1000 at 0 °C
Room temperature range	0...50 °C
Outdoor temperature range	-50...80 °C
- Pt type	Pt1000_375/Pt1000_385 at 0 °C
Room temperature range	0...50 °C
Outdoor temperature range	-50...80 °C
Active DC 0 V ...10 V sensors	Min./max. configurable via parameters
- Room temperature range (default)	0...50 °C
- Outdoor temperature range (default)	-50...80 °C
- Humidity range (default)	0...100%
Digital contacts	
- Operating action	Selectable NO/NC

### Connections to multifunctional inputs X1 - M - X2

- Contact sensing	DC 14...40 V, 8 mA (typ.)
- Parallel connection	Max. 20 thermostats per switch
- Input function	Selectable

## Outputs

### Switching capacity of relay

Voltage Q11, Q12, Q14	Potential free, AC 24...230 V
Current, min max resistive (inductive)	5 mA...5(2) A
Voltage Q21, Q22, Q24	Potential free, AC 24...230 V
Current, min max resistive (inductive)	5 mA...5(2) A
Note: Connecting different voltages on Q1x and Q2x is allowed (double insulation).	



### NOTICE

Remove wired bridge L-Q11 when loads work with voltages other than AC 230 V.

## Operational data

### Setpoint setting range

12...35 °C

### Built-in room temperature sensor

Temperature range	Accuracy at 25 °C	Display resolution
0...50 °C	±0.5 K	0.5 K

### Built-in room humidity sensor

Humidity range	Accuracy at 25 °C	Display resolution
0%...100%	±5% r.h.	1%

## Connections

### Interfaces

Micro USB	A service port is limited to firmware upgrades and onsite diagnosis by professionals.
-----------	---

### Wiring connections

Screw terminals	Solid wires or prepared stranded wires: Max. 1 × 0.5... 2.5 mm <sup>2</sup> (14...20 AWG)
-----------------	--

## Conformity

Ambient conditions and protection classification	
Safety class as per EN60730	Class II
Degree of protection of housing as per EN 60529	IP30
Classification as per EN 60730	
Function of automatic control devices Degree of contamination Overvoltage category	Type 1 2 III
Climatic ambient conditions	
Storage as per EN 60721-3-1	Class 1K3 Temperature -25...65 °C (-13... 149 °F) Humidity 5...95%
Transport (packaged for transport) as per EN 60721-3-2	Class 2K3 Temperature -25...65 °C (-13... 149 °F) Humidity 5...95%
Operation as per EN 60721-3-3	Class 3K5 Temperature -5...50 °C (23... 122 °F) Humidity 5...95%
Mechanical ambient conditions	
Storage as per EN 60721-3-1 Transport as per EN 60721-3-2 Operation as per EN 60721-3-3	Class 1M2 Class 2M2 Class 3M2

Standards, directives and approvals	
EU conformity (CE)	A5W90002476 <sup>*)</sup>
RCM conformity	A5W90002477 <sup>*)</sup>
China CMIIT ID	2017DJ1647, A5W90002478 <sup>*)</sup>
EAC conformity	Eurasian Conformity <sup>*)</sup>
Environmental compatibility	The product environmental declaration A5W90003412 <sup>*)</sup> contains data on environmentally compatible product design and assessments (RoHS compliance, materials composition, packaging, environmental benefit, disposal).

<sup>\*)</sup> The documents can be downloaded from <http://siemens.com/bt/download>.

eu.bac certification				
Type	License	Application	Energy Efficiency Label	Control accuracy (K)
RDS110	217739	Water heating systems (radiator)	AA	0.5
	See product list at: <a href="http://www.eubaccert.eu/licences-by-criteria.asp">http://www.eubaccert.eu/licences-by-criteria.asp</a>			

Eco design and labeling directives			
	Based on EU Regulation 813/2013 (Eco design directive) and 811/2013 (Labelling directive) concerning space heaters, combination heaters, the following classes apply:		
	Application with On/Off operation of a heater	Class I	Value 1%
	PWM (TPI) room thermostat, for use with On/Off output heaters	Class IV	Value 2%

## General data

General		
Dimension	Refer to Dimensions on page 18	
Weight	Thermostat with package, user document and accessory	435 g
	Thermostat	231 g
Color	Silver plating Housing: Pantone black	

## Diagrams

### Connection terminals

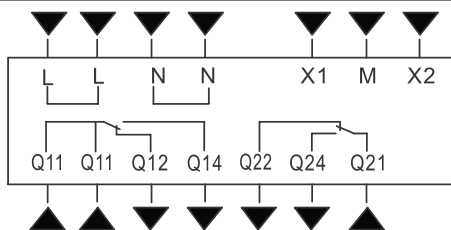

Terminal	Use
L	Mains connection, live conductor
N	Mains connection, neutral conductor
Q11	Control input (com)
Q12	Control output; NC contact

Terminal	Use
Q14	Control output; NO contact
Q21	Control input (com)
Q22	Control output; NC contact
Q24	Control output; NO contact
X1, X2, M	Multifunctional inputs

## Wiring diagrams

- The thermostat is delivered with one wired bridge ① (L-Q11) for easy installation of AC 230 V HVAC equipment (example 1).
- When loads use voltages other than AC 230 V, bridge ① must be removed before wiring the loads to the thermostat (example 2).
- If the load current through Y2 is more than 3 A, bridge between L-Q11 cannot be used. Adapt parameter “Q22/Q24 electrical load” in “Advanced Settings” / “Optimization”.
- For application with higher currents ( $Y1 > 3 \text{ A}$  or  $Y2 > 2 \text{ A}$ ), adapting parameter “Q22/Q24 electrical load” in “Advanced Settings” / “Optimization” accordingly is recommended.

### Basic

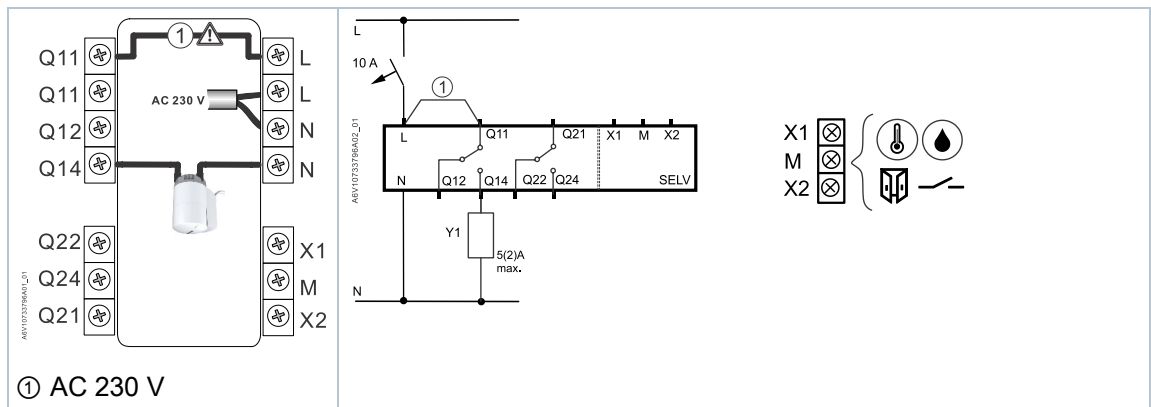

### Advanced

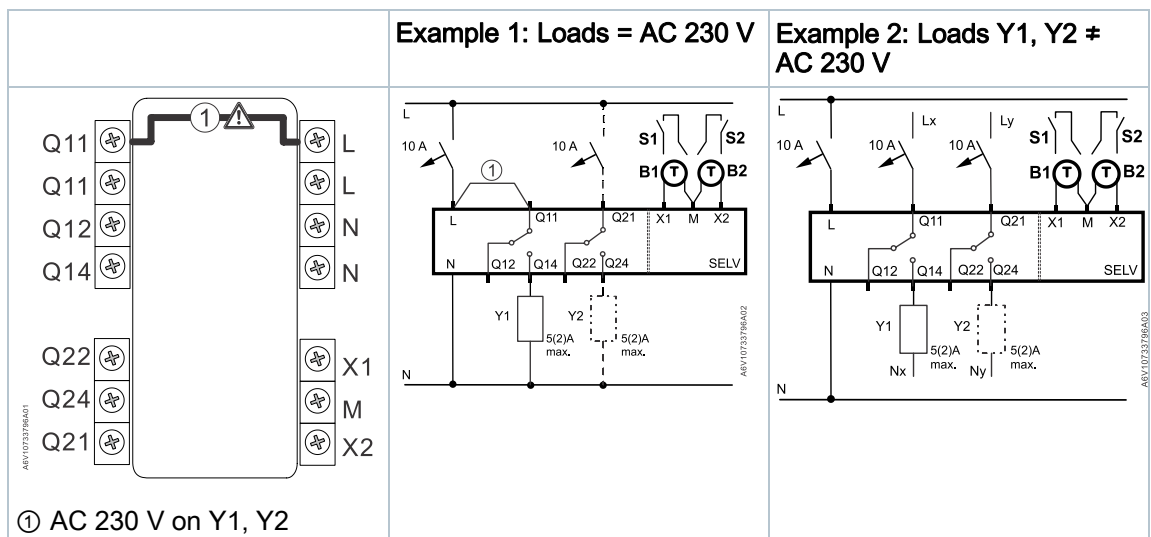

Y1 HVAC equipment  
Y2 DHW / Dehumidifier / Humidifier

B1, B2 External sensors  
S1, S2 External switches



**⚠ WARNING**

**The total current rating must not exceed 8 A.**



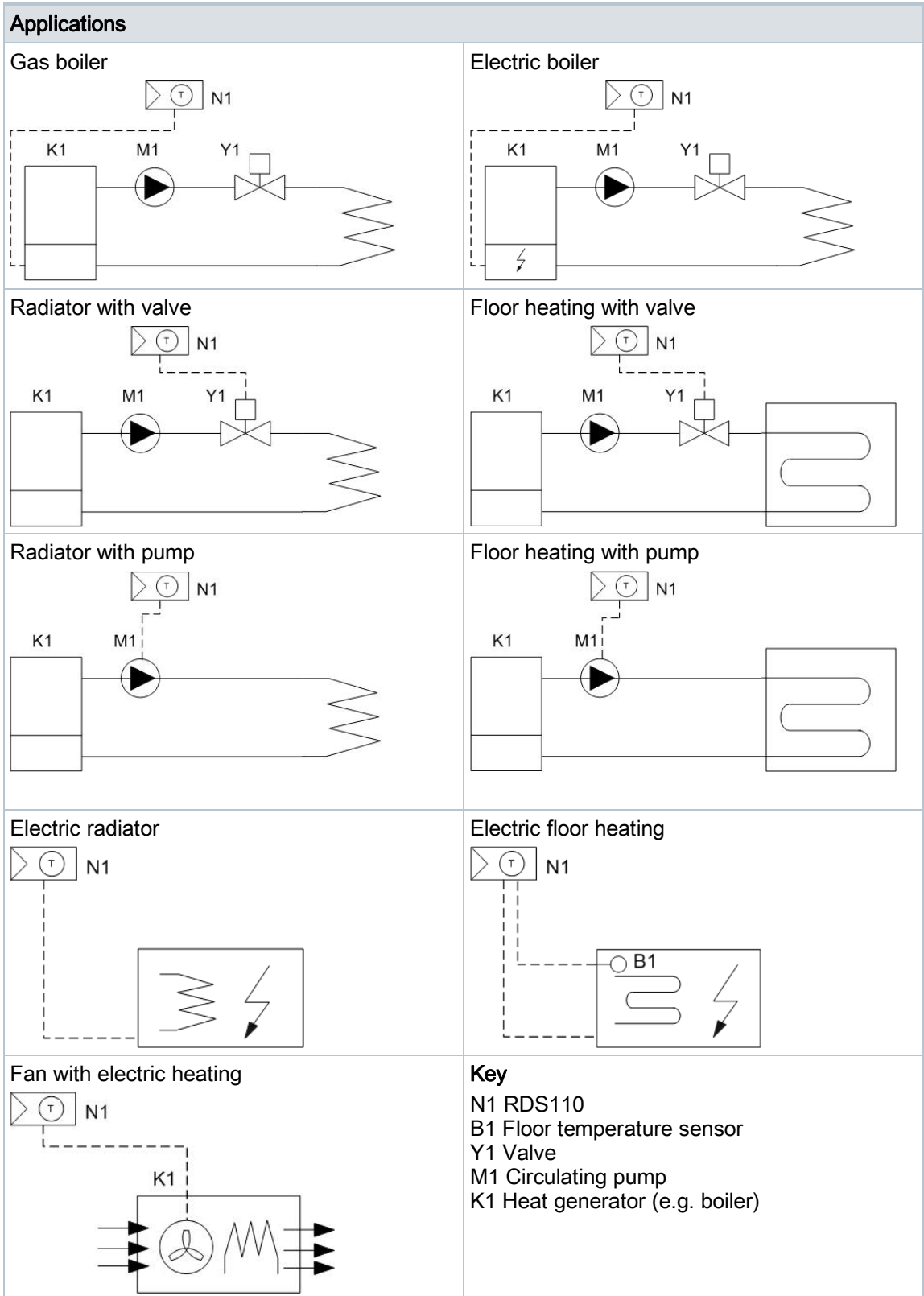

RDS110

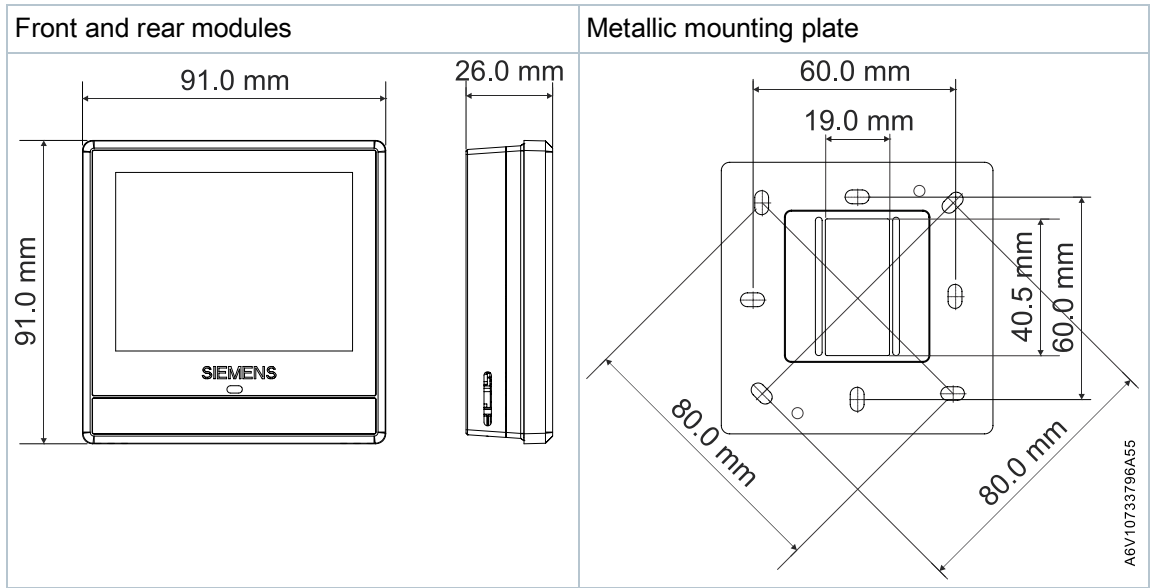

ARG100.01

White decoration frame

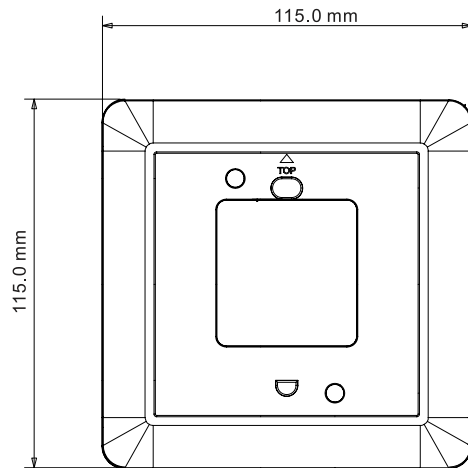

Metallic mounting plate

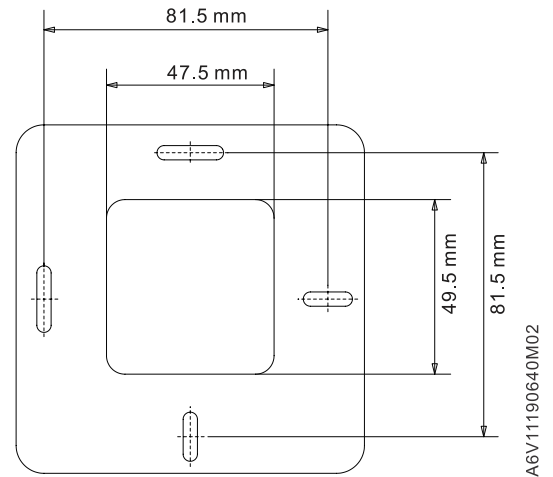

## Revision history

Edition	Date	Software version	Changes	Section	Pages
5	July 2018	32.2.27 or higher	-	-	-
4	May 2018	32.2.18 or higher	<ul style="list-style-type: none"> <li>• Added EAC logo</li> <li>• Added EAC conformity</li> <li>• Updated application names</li> </ul>	Cover page Technical data Application examples	1 13 17
3	April 2018	32.2.18 or higher	<ul style="list-style-type: none"> <li>• Added standby power consumption figure.</li> </ul>	Technical data	11
2	January 2018	32.2.18 or higher	<ul style="list-style-type: none"> <li>• Changed operating modes from Comfort, Pre-comfort and Economy to Comfort, Economy and Unoccupied.</li> <li>• Added "Dark" and "Light" background color support for mobile app.</li> </ul>	Remote operation and monitoring	2
1	August 2017	32.2.10	New document	---	---

Issued by  
Siemens Switzerland Ltd.  
Building Technologies Division  
International Headquarters  
Theilerstrasse 1a  
CH-6300 Zug  
Tel. +41 58 724 2424  
[www.siemens.com/buildingtechnologies](http://www.siemens.com/buildingtechnologies)

© Siemens Switzerland Ltd, 2018  
Technical specifications and availability subject to change without notice.