



RDF600KN



RDF600KN/VB



RDF600KN/S

Semi flush-mount communicating room thermostats

RDF600KN
RDF600KN/VB
RDF600KN/S

For 2-pipe, 2-pipe with electric heater, and 4-pipe fan coil units

For use with compressors in DX type equipment

- KNX bus communications (S-mode and LTE mode)
- Backlit display
- 2P / PI / P control
- Outputs for on/off or 3-position control
- Outputs for 3-speed or 1-speed fan
- 2 multifunctional inputs for keycard contact, external sensor, etc.
- Operating modes: Comfort, Economy and Protection
- Automatic or manual fan speed control
- Automatic or manual heating/cooling changeover
- Minimum and maximum limitation of room temperature setpoint
- Control depending on the room or the return air temperature
- Adjustable commissioning and control parameters
- Commissioning with Synco ACS, ETS or via local HMI
- Integration into Synco
- Integration into Desigo via group addressing (ETS) or via individual addressing
- Integration into third-party system via group addressing (ETS)
- AC 230 V operating voltage
- User and parameter settings can be retained or restored with power loss

Additional RDF600KN/S features:

- **Four buttons to control KNX actuators via KNX S-mode (functions: switching, dimming, blinds control, 8-bit scene)**

Use

Room temperature control (heating or cooling) in individual rooms and zones by means of:

- 2-pipe fan coil units
- 2-pipe fan coil units with electric heater
- 4-pipe fan coil units
- Compressors in DX-type equipment
- Compressors in DX-type equipment with electric heater

The thermostats control:

- One 1-speed or 3-speed fan
- One or two on/off valve actuators
- One on/off valve actuator and one 1-stage electric heater
- One 3-position valve actuator
- One 1-stage compressor in DX-type equipment, or one 1-stage compressor with electric heater

Used in systems with:

- Heating or cooling mode
- Automatic heating/cooling changeover
- Manual heating/cooling changeover
- Heating and cooling mode (e.g. 4-pipe system)

The room thermostats are delivered with a fixed set of applications.

The relevant application is selected and activated during commissioning using one of the following tools:

- Synco ACS
- ETS
- Local DIP switch and HMI

- Room temperature control via built-in temperature sensor or external room temperature / return air temperature sensor.
- Changeover between heating and cooling mode (automatically via local sensor or bus, or manually).
- Selection of applications via DIP switches or commissioning tool.
- Selection of operating mode via operating mode button on the thermostat.
- Temporary Comfort mode extension.
- 1-speed or 3-speed fan control (automatically or manually).
- Display of current room temperature or setpoint in °C and/or °F.
- Minimum and maximum limitation of room temperature setpoint.
- Button lock (automatically and manually).
- 2 multifunctional inputs, freely selectable for:
 - Sensor for automatic heating/cooling changeover
 - External room temperature or return air temperature sensor
 - Dew point sensor
 - Electric heater enable
 - Fault input
 - Monitor input for temperature sensor or switch state
 - Window contact
 - Presence detector (standard presence and hotel presence)
- Advanced fan control function, e.g. fan kick, fan start, selectable fan operation (enable, disable or depending on heating or cooling mode).
- Purge function together with 2-port valve in a 2-pipe changeover system.
- Reminder to clean fan filters (adjust with P62).
- Floor heating temperature limitation.
- Reload factory settings for commissioning and control parameters.
- KNX bus (terminals CE+ and CE-) for communication with Synco or KNX compatible devices.
- Display of outdoor temperature or time of day via KNX bus.
- Time scheduling and central control of setpoints via KNX bus.
- With a Synco RMx7xx controller, the energy demand signal of the thermostat is used to optimize energy supply.

RDF600KN/S only:

- Four buttons to control KNX actuators via KNX S-mode. ("Switching groups" with functions such as switching, dimming, blinds control, 8-bit scene).

Applications

The thermostats support the following applications, which can be configured using the DIP switches on the inner side of the thermostat's front panel or a commissioning tool.

Remote configuration

All DIP switches need to be set to OFF (remote configuration, factory setting) to select an application via commissioning tool.

Remote configuration, via commissioning tool (factory set)

- Synco ACS
- ETS

DIP switches

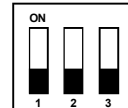

Applications for fan coil systems

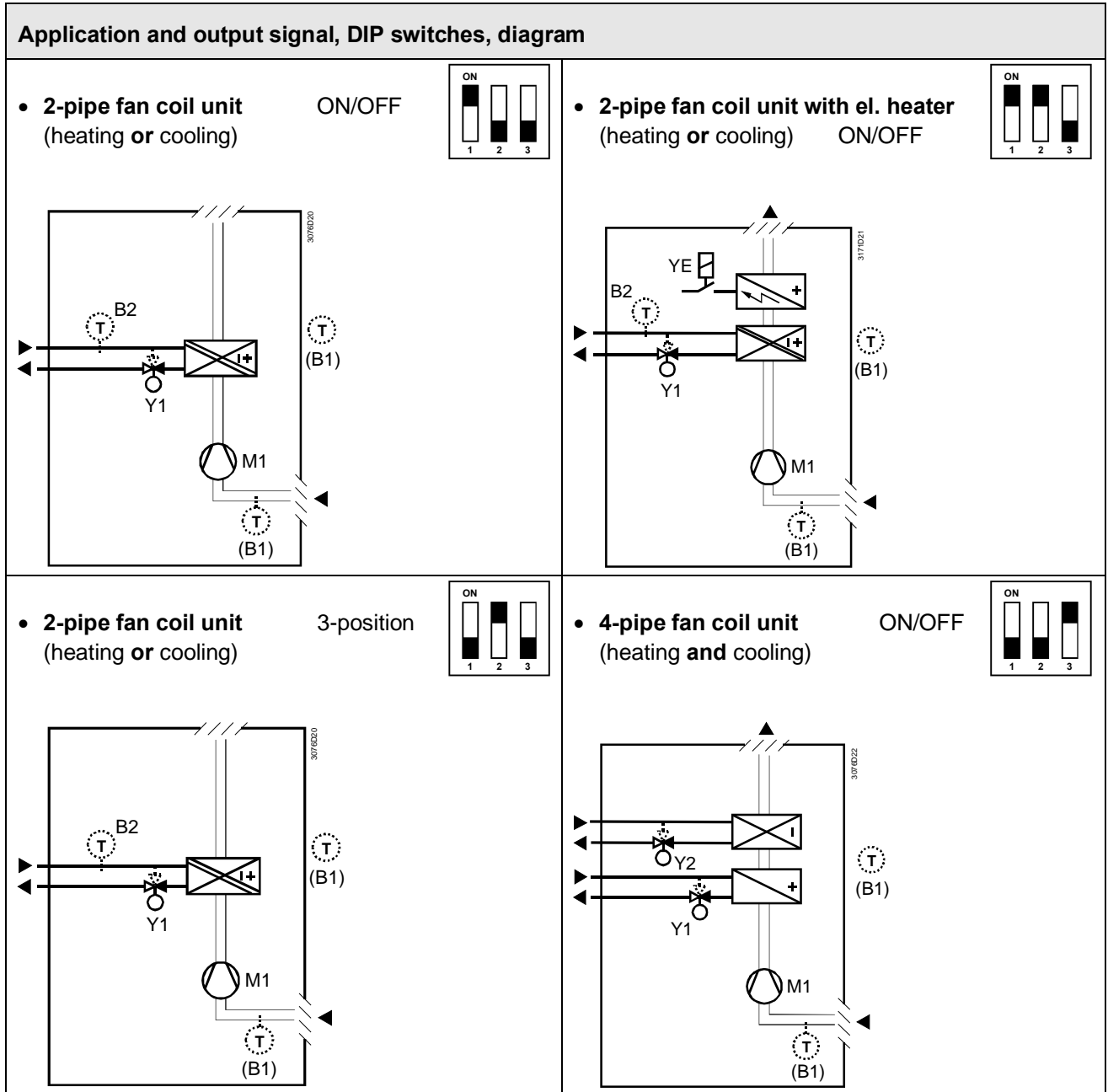

Legend

Y1 Heating or heating/cooling valve actuator
 Y2 Cooling valve actuator
 YE Electric heater
 N1 Thermostat

B1 Return air temperature sensor or external room temperature sensor (optional)
 B2 Changeover sensor (optional)
 M1 1-speed or 3-speed fan

Applications for Universal systems

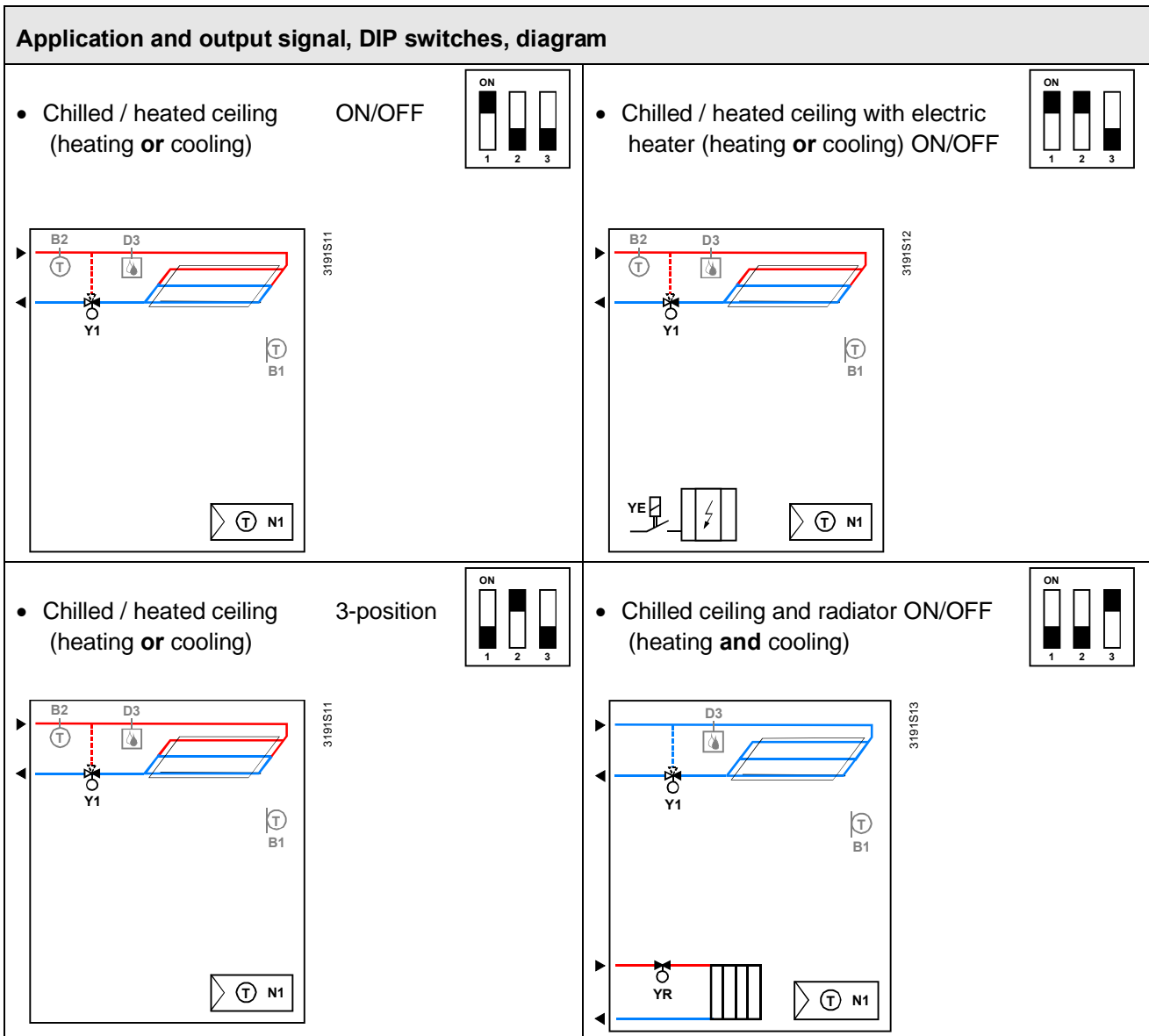

Legend

Y1 Heating or heating/cooling valve actuator
 YR Radiator valve actuator
 YE Electric heater
 N1 Thermostat

B1 Return air temperature sensor or external room temperature sensor (optional)
 B2 Changeover sensor (optional)
 M1 1-speed or 3-speed fan
 D3 Dewpoint sensor

Applications for heat pump systems

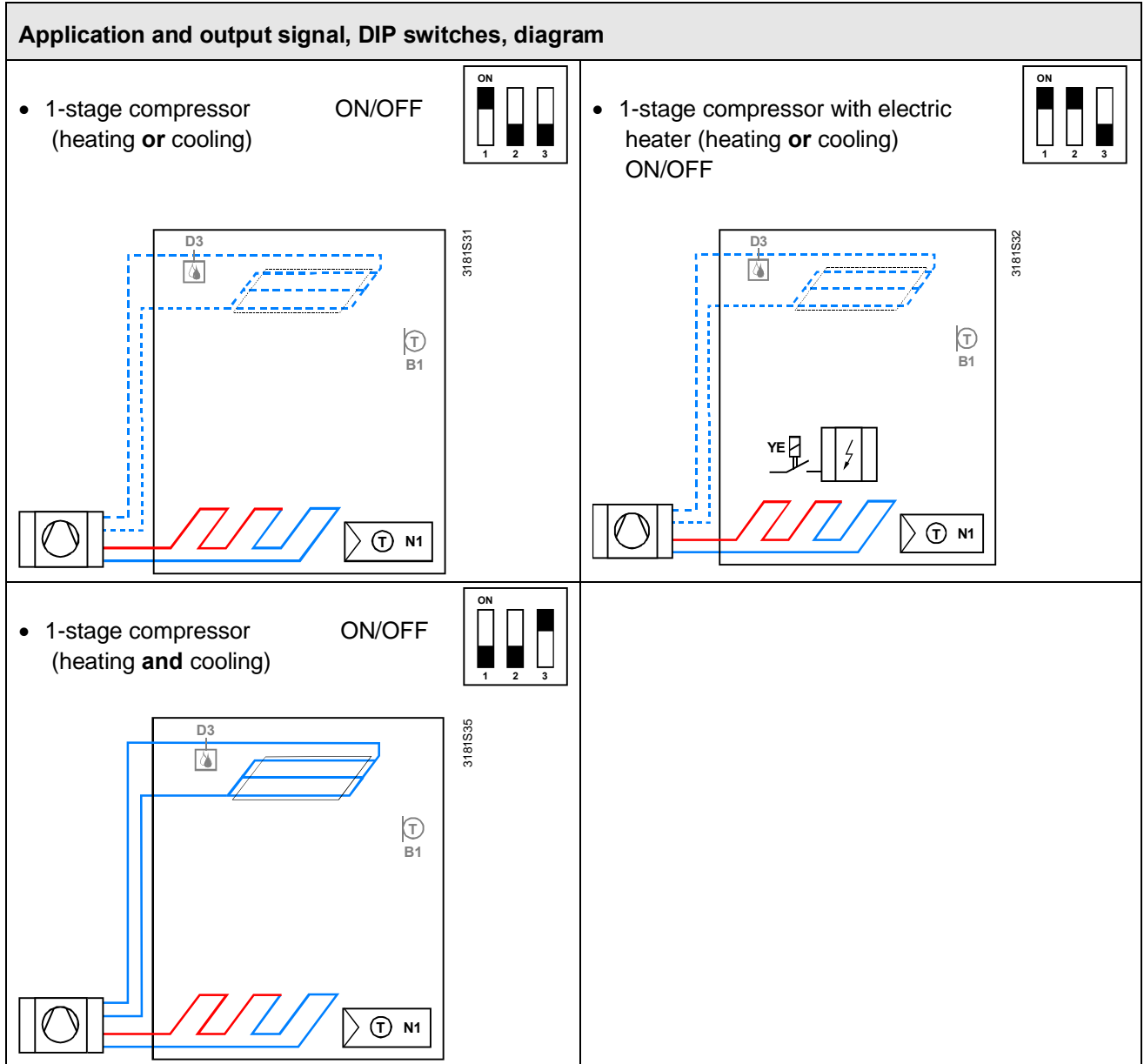

- | | | |
|--------|--------------------|---|
| Legend | N1 Thermostat | B1 Return air temperature sensor or external room temperature sensor (optional) |
| | YE Electric heater | D3 Dewpoint sensor |

Type summary

Product no.	Stock no.	Operating voltage	Control outputs		Suitable conduit box ²⁾	Color
			3-pos	ON/OFF		
RDF600KN	S55770-T293	AC 230 V	1 ¹⁾	2 ¹⁾	round or square	White
RDF600KN/S ³⁾	S55770-T400	AC 230 V	1 ¹⁾	2 ¹⁾	round or square	White
RDF600KN/VB	S55770-T430	AC 230 V	1 ¹⁾	2 ¹⁾	round or square	Black

¹⁾ Selectable: on/off or 3-position.

²⁾ Square conduit box with 60 mm fixed centers.

Round CEE conduit box min 60 mm diameters and min 40 mm depth.









³⁾ Control outputs: KNX switching groups

Ordering





- When ordering, indicate both product number / SSN number and name:
E.g. **RDF600KN/ S55770-T293 room thermostat**
- Order valve actuators separately.

Equipment combinations

On/off actuators

Type of unit		Product no.	Data sheet*)
Cable temperature sensor or changeover sensor		QAH11.1	1840
Room temperature sensor		QAA32	1747
Condensation monitor		QXA21..	A6V10741072
Electromotoric ON/OFF actuator		SFA21...	4863
Electromotoric ON/OFF valve and actuator (only available in AP, UAE, SA and IN)		MVI.../ MXI...	A6V11251892
Zone valve actuators (only available in AP, UAE, SA and IN)		SUA...	4832
Thermal actuator (for radiator valves), NO		STA23...	4884
Thermal actuator (for small valves 2.5 mm), NC		STP23...	4884

3-position actuators

Electrical actuator, 3-position (for radiator valve)		SSA31...	4893
Electrical actuator, 3-position (for 2- and 3-port valves / V...P45)		SSC31	4895
Electrical actuator, 3-position (for small valve 2.5 mm)		SSP31...	4864
Electrical actuator, 3-position (for small valve 5.5 mm)		SSB31...	4891
Electrical actuator, 3-position		SAS31...	4581



*) The documents can be downloaded from <http://siemens.com/bt/download>.

Note:

For the maximal number of actuators in parallel, refer to information in the data sheets of the selected actuators and to this list, depending on which value is lower:

- Parallel operation of max 6 SS... actuators (3-pos) is possible.
- Parallel operation of max 10 on/off actuators is possible.

Accessories

Designation		Product no. / SSN	Data sheet
Changeover mounting kit (50 pcs/package)		ARG86.3	N3009
Plastic mounting bracket for semi-flush-mount thermostats for increasing the headroom in the conduit box by 10mm		ARG70.3	N3009
KNX Power supply 160 mA (Siemens BT LV)		5WG1 125-1AB02	--
KNX Power supply 320 mA (Siemens BT LV)		5WG1 125-1AB12	--
KNX Power supply 640 mA (Siemens BT LV)		5WG1 125-1AB22	--

Mechanical design

The thermostats consist of 2 parts:

- Front panel with electronics, operating elements and built-in room temperature sensor.
- Mounting base with power electronics.

The rear of the mounting base contains the screw terminals.
Slide the front panel in the mounting base and snap on.

Operation and settings

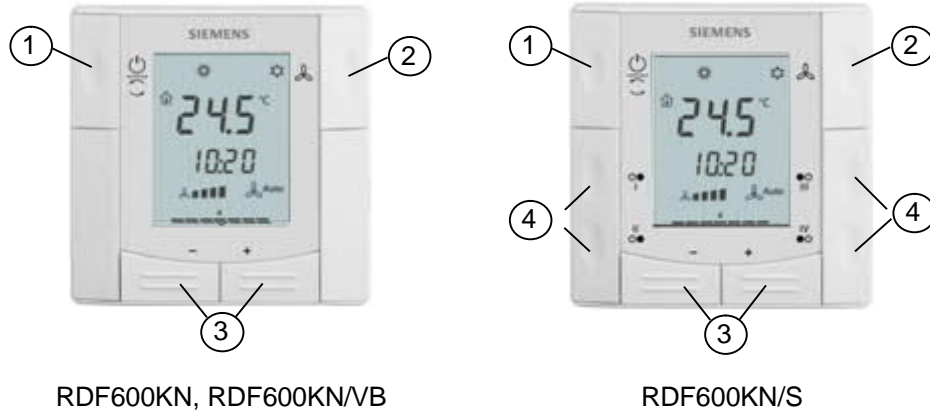

- 1 Operating mode selector
- 2 Change fan operation
- 3 Adjust setpoint and control parameters
- 4 Four buttons to control KNX actuators via KNX S-mode (functions: switching, dimming, blinds control, 8-bit scene)

Display

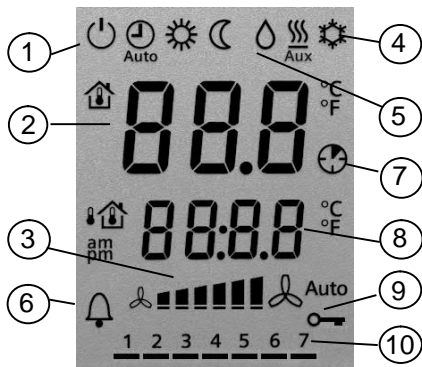

- 1 Operating mode
 - ⏻ Protection
 - ☀ Comfort
 - 🌙 Economy
 - 🕒 Auto Timer according to schedule (via KNX)
- 2 Displays room temperature, setpoints and control parameters.
 - 🏠 Symbol indicates current room temperature
- 3 Fan mode
 - 🌀 Auto Auto fan active
 - 🌀 Fan speed low, medium, high
- 4 Heating/cooling mode
 - ❄ Cooling
 - 🔥 Heating
 - 🔥 Aux Electric heater active
- 5 💧 Condensation in room (dewpoint sensor active)
- 6 🔔 Indicates fault or reminder
- 7 🌐 Temporary comfort mode extension active
- 8 Additional user information, like outdoor temperature 🏠 or time of day from KNX bus. Selectable via parameters
- 9 🔒 Button lock active
- 10 1 2 3 4 5 6 7 Weekday 1...7 from KNX bus (1 = Monday / 7 = Sunday)

See "Reference documentation" on page 15 for information on how to engineer the KNX bus (topology, bus repeaters, etc.) and how to select and dimension connecting cables for supply voltage and field devices.

Mounting and installation

Mount the room thermostat on a conduit box. Do not mount on a wall in niches or bookshelves, behind curtains, above or near heat sources, or exposed to direct solar radiation. Mount about 1.5 m above the floor.

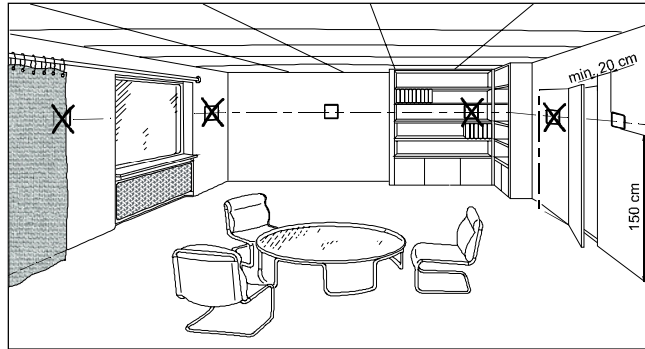

Mounting / Dismounting



- Mount the room thermostat on a clean, dry indoor place without direct airflow from a heating/cooling device, and not exposed to drips or splash water.
- In case of limited space in the conduit box use the mounting bracket ARG70.3 to increase the headroom by 10 mm.

Wiring

See the mounting instructions M3171... and M3076.3 enclosed with the thermostat.



- Comply with local regulations to wire, protection and earth the thermostat.

Warning!

No internal line protection for supply lines to external consumers (Q1, Q2, Q3, Yxx)

Risk of fire and injury due to short-circuits!

- Adapt the line diameters as per local regulations to the rated value of the installed overcurrent protection device.
- The AC 230 V mains supply line must have an external circuit breaker with a rated current of no more than 10 A.
- Properly size the cables to the thermostat, fan and valve actuators for AC 230 V mains voltage.
- Use only valve actuators rated for AC 230 V.
- Cables of SELV inputs X1-M/X2-M: Use cables with 230 V insulation, as the conduit box carries AC 230 V mains voltage.
- Inputs X1-M or X2-M of different units (e.g. summer/winter switch) may be connected in parallel with an external switch. The maximum contact current rating for the external switch should fulfill the overall sensing current of all connected inputs.
- KNX communication cables (input CE+ / CE-): Use cables with 230 V insulation, as the conduit box carries AC 230 V mains voltage.
- Disconnect from supply before opening the cover.
- When a KNX bus power supply is connected on the line with communicating thermostats and Synco controller, the internal KNX power supply of the Synco controllers must be switched off.



Applications

The room thermostats are delivered with a fixed set of applications.

Select and activate the relevant application during commissioning using one of the following tools:

- Local DIP switch and HMI
- Synco ACS
- ETS

Set the DIP switches before snapping the front panel to the mounting plate, if you want to select an application via **DIP switches**.

All DIP switches need to be set to "OFF" ("remote configuration"), if you want to select an application via **commissioning tool**.

After power is applied, the thermostat resets and all LCD segments flash, indicating that the reset was correct. After the reset, which takes about 3 seconds, the thermostat is ready for commissioning by qualified HVAC staff.

If all DIP switches are OFF, the display reads "NONE" to show that an application needs to be set via tool.

Note Each time the application is changed, the thermostat reloads the factory setting for all control parameters, except for KNX device and zone addresses!

Connect tool

Connect the Synco ACS or ETS tools to the KNX bus cable at any point for commissioning:

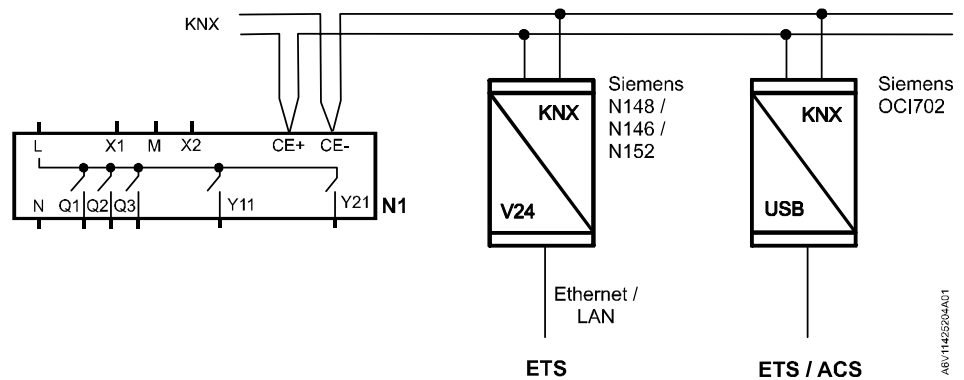

ACS and ETS require an interface:

- Ethernet/LAN KNX interface (e.g. Siemens N148 / N146 / N152)
- OC1702 USB- KNX interface

Note An external KNX bus power supply is required if an RDF600KN... is connected directly to a tool (ACS or ETS) via KNX interface.

Control parameters

The thermostat's control parameters can be set to ensure optimum performance of the entire system (see basic documentation P3171).

The parameters can be adjusted using

- Local HMI
- Synco ACS
- ETS

Control sequence

- The control sequence may need to be set via parameter P01 depending on the application. The factory setting for the 2-pipe application is "Cooling only"; and "Heating and Cooling" for the 4-pipe application.

Compressor-based application

- When the thermostat is used with a compressor, adjust the minimum output on-time (parameter P48) and off-time (parameter P49) for Y11/Y21 to avoid damaging the compressor or shortening its life due to frequent switching.

Calibrate sensor

- Recalibrate the temperature sensor if the room temperature displayed on the thermostat does not match the room temperature measured (after min. 1 hour of operation). To do this, change parameter P05.

Setpoint and range limitation

- We recommend to review the setpoints and setpoint ranges (parameters P08...P12) and change them as needed to achieve maximum comfort and save energy.

Programming mode

The programming mode helps identify the thermostat in the KNX network during commissioning.

Press buttons "operating mode"  and "+" simultaneously for 6 sec to activate programming mode, which is indicated on the display with "PrO9".

Programming mode remains active until thermostat identification is complete.

Assign KNX device address

Assign device address (P81) via HMI, ACS or ETS.

With device address set to 255, the communication is deactivated (no exchange of process data).

Assign KNX group addresses

Use ETS to assign the KNX group addresses of the RDF communication objects.

Switching groups RDF600KN/S only

RDF600KN/S has 2 switching groups with a pair of buttons each, which must be configured via ETS. The switching groups only work on S-mode.

KNX serial number

Each device has a unique KNX serial number inside the front panel. An additional sticker with the same KNX serial number is enclosed in the packaging box. This sticker is intended for installers for documentation purposes.

Disposal



The device is considered electrical and electronic equipment for disposal in terms of the applicable European Directive and may not be disposed of as domestic garbage.

- Dispose of the device through channels provided for this purpose.
- Comply with all local and currently applicable laws and regulations.

Technical data

⚠ Power supply	Rated voltage	AC 230 V
	Overvoltage category	III
	Frequency	50/60 Hz
	Power consumption	Max. 3.5 VA / 1.2 W
⚠ Caution	No internal fuse	
	External preliminary protection with max C 10 A circuit breaker required in all cases	
Outputs	Fan control Q1, Q2, Q3-N	AC 230 V
	Rating min, max resistive (inductive)	Min. 5 mA, Max. 5(2) A
⛔ Note!	Fans must NOT be connected in parallel!	
	Connect one fan directly, for additional fans, one relay for each speed	
	Control output Y11-N / Y21-N (NO)	AC 230 V
	Rating min, max resistive (inductive)	Min. 5 mA, Max. 5(2) A
⚠ Caution	Max. total load current through terminal "L" (Qx+Yxx)	Max. 7A
	No internal fuse	
	External preliminary protection with max. C 10 A circuit breaker in the supply line required under all circumstances	

Inputs	Multifunctional input X1-M/X2-M	
	Temperature sensor input:	
	Type	QAH11.1 (NTC)
	Temperature range	0...49 °C
	Cable length	Max. 80 m
	Digital input:	
	Operating action	Selectable (NO / NC)
	Contact sensing	SELV DC 0...5 V/max 5 mA
	Parallel connection of several thermostats for one switch	Max. 20 thermostats per switch
	Insulation against mains voltage (SELV)	4 kV, reinforced insulation
	Function of inputs:	Selectable
External temperature sensor, heating/cooling changeover sensor, operating mode switchover contact, dewpoint monitor contact, enable electric heater contact, fault contact, monitoring input	X1: P38 X2: P40	
KNX bus	Interface type	KNX, TP1-64 (electrically isolated)
	Bus current	5 mA
	Bus topology: See KNX manual (reference documentation, see below)	
Operational data	Switching differential, adjustable	
	Heating mode (P30)	2 K (0.5...6K)
	Cooling mode (P31)	1 K (0.5...6K)
	Setpoint setting and range	
	☀ Comfort (P08)	21 °C (5...40 °C)
	☾ Economy (P11-P12)	15 °C/30 °C (OFF, 5...40 °C)
	🔌 Protection (P65-P66)	8 °C/OFF (OFF, 5...40 °C)
	Multifunctional input X1/X2	
	Input X1 default value (P38)	3 (Operating mode switchover)
	Input X2 default value (P40)	1 (External temperature sensor)
	Built-in room temperature sensor	
Measuring range	0...49 °C	
Accuracy at 25 °C	< ± 0.5 K	

	Temperature calibration range	± 3.0 K
	Settings and display resolution	
	Setpoints	0.5 °C
	Current temperature value displayed	0.5 °C
Environmental conditions	Storage	As per IEC 60721-3-1
	Climatic conditions	Class 1K3
	Transport	As per IEC 60721-3-2
	Climatic conditions	Class 2K3
Standards and directives	Operation	As per IEC 60721-3-3
	Climatic conditions	Class 3K5 ¹⁾
	EU conformity (CE)	A6V10386381 ¹⁾
	Electronic control type	2.B (micro-disconnection on operation)
	 RCM Mark conformity (Emission)	CE1T3076en-C ¹⁾
	Safety class	II as per EN 60730
	Pollution class	Normal
	Degree of protection of housing	IP 30 as per EN 60529
	Housing flammability class according to UL94	V-0
Environmental Compatibility	The product environmental declaration CE1E3076_4en ¹⁾ (for RDF600KN, RDF600KN/S), A5W00085841A ¹⁾ (RDF600KN/VB) contains data on environmentally compatible product design and assessments (RoHS compliance, materials composition, packaging, environmental benefit, disposal).	
General	Connection terminals	Solid wires or prepared stranded wires
	Minimal wiring cross section on L, N, Q1, Q2, Q3, Y11, Y21	1 x 0.4...1.5 mm ² min 1.5 mm ²
	Housing front color	RAL 9003 white RAL 9004 black
	Weight without / with packaging	0.150 kg / 0.220 kg

¹⁾ The documents can be downloaded from <http://siemens.com/bt/download>.

¹⁾ No condensation is allowed.

Reference documentation	Handbook for Home and Building Control - Basic Principles (https://my.knx.org/shop/product?language=en&product_type_category=books&product_type=handbook)
Synco	CE1P3127 Communication via the KNX bus for Synco 700, 900 and RXB/RXL Basic documentation
Desigo	CM1Y9775 Desigo RXB integration – S-mode CM1Y9776 Desigo RXB / RXL integration – individual addressing CM1Y9777 Third-party integration CM1Y9778 Synco integration CM1Y9779 Working with ETS

Connection terminals

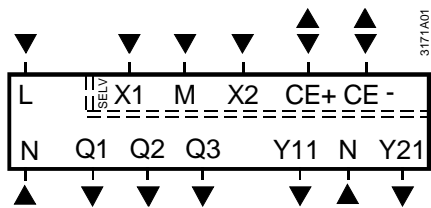

L, N	Operating voltage AC 230 V
Q1	Control output "Fan speed 1 AC 230 V"
Q2	Control output "Fan speed 2 AC 230 V"
Q3	Control output "Fan speed 3 AC 230 V"
Y11, Y21	Control output "Valve" AC 230 V (N.O., for normally closed valves), output for compressor or output for electric heater
X1, X2	Multifunctional input for temperature sensor (e.g. QAH11.1) or potential-free switch Factory setting: – X1 = Operating mode switchover contact – X2 = External sensor (function can be selected via parameter P38 / P40).
M	Measuring neutral for sensor and switch
CE+	KNX data +
CE-	KNX data -

Connection diagrams

Application

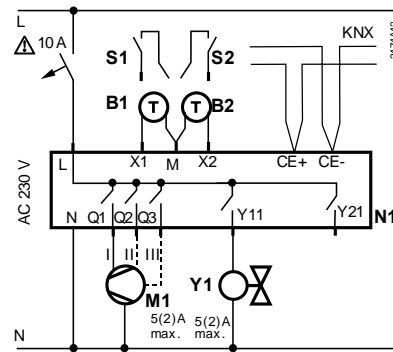

2-pipe, 2-position

2-pipe, 3-position

- Y11 = Open
- Y21 = Close

2-pipe and electric heater

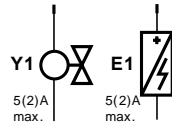
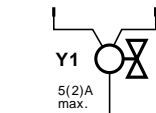

4-pipe

- Y1 = Heating
- Y2 = Cooling

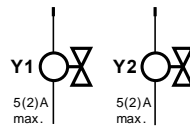

1-stage compressor

- C1 = Heating and / or
- C2 = Cooling)

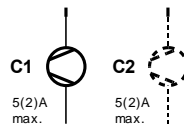

1-stage compressor and electric heater

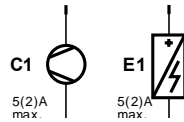

N1	Room thermostat RDF600KN...
M1	1-speed or 3-speed fan
Y1	Valve actuator, 2-position or 3-position
Y1, Y2	Valve actuator, 2-position
E1	Electric heater
C1, C2	1-stage compressor
S1, S2	Switch (keycard, window contact, presence detector, etc.)
B1, B2	Temperature sensor (return air temperature, external room temperature, changeover sensor, etc.)
CE+	KNX data +
CE-	KNX data -

Dimensions

Dimensions in mm

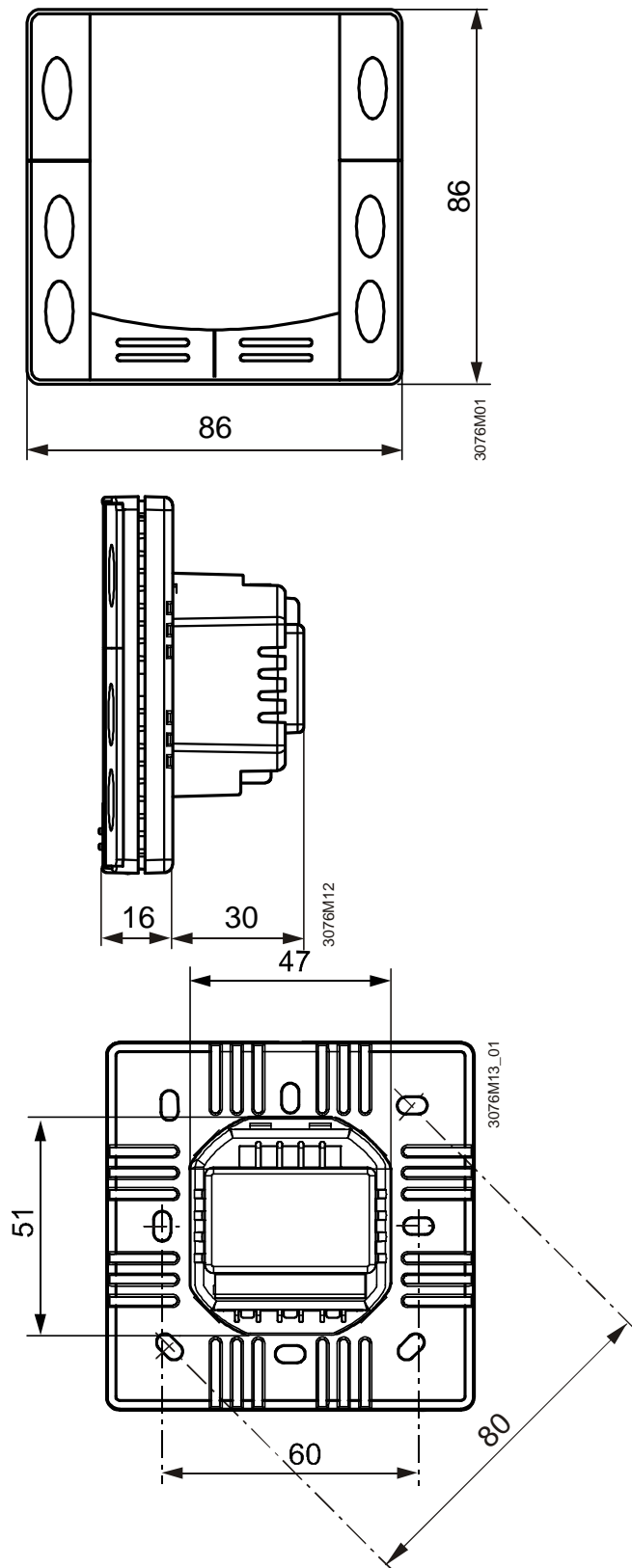

Issued by
Siemens Switzerland Ltd
Smart Infrastructure
Global Headquarters
Theilerstrasse 1a
CH-6300 Zug
Tel. +41 58 724 2424
www.siemens.com/buildingtechnologies
18 / 18

© Siemens Switzerland Ltd, 2019
Technical specifications and availability subject to change without notice.